

The Model T Ignition Coil

Part I: The Ford/K-W Ignition Company Story

By Trent Boggess and Ronald Patterson

“All in all, the magneto commutator coil units supplied by the Ford Motor Company did a better and more creditable job than anything offered by the accessory firms.”

- Reminiscences of H.L. Maher

What could be more characteristic of a Model T Ford than a box containing four vibrator ignition coils on the dash? Coils that always sound like a nest full of angry bees. Coils that sometimes will reward the Model T driver with a “free start” if when the engine was turned off, one of the pistons stopped just after top-dead center on the compression stroke.

The vibrator ignition coil system did not originate with the Model T, nevertheless; the Model T was its most famous application. In this and the following two articles we will attempt to comprehensively present the story of the Model T ignition coil. Part 1 presents a brief history of the Model T ignition coil beginning with the evolution of the timer and vibrator coil ignition system in early Ford design automobiles. We will also go on to describe the various brands of ignition coils used on Model Ts during the first five years of production and some of the problems that developed with these coils.

In Part 2 we will present the story of how Ford came to standardize on the ignition coil designed by Joseph Williams of the K-W Ignition Company in 1913 and the subsequent business relationship between Ford and K-W Ignition. Finally, in Part 3, we will attempt to construct an anthology of the various types of post-1913 ignition coils used on the Model T, describing their features and roughly dating their use.

Two of the thorniest problems in the development of the internal combustion engine were the issues of carburetion and ignition. The first involved getting the right mixture of highly combustible fuel and air into the cylinders and the second involved igniting it at just the right moment. Henry Ford's first car, the 1896 Quadricycle, took a brut-force direct approach to solving both of these problems. Carburetion was achieved by the expedient of a needle valve that allowed gasoline to drip into the intake manifold at a more or less controlled rate. Once in the manifold, the gas would be swept up and drawn into the cylinders by the air rushing through the

manifold on the intake stroke. Once in the cylinders, the air-fuel mixture was compressed and made ready for ignition. Again Ford adopted a direct approach to solving this problem. The mixture was ignited by a technique known as “make and break.” This simple ignition system had been in use in stationary gas engines for a number of years and was later used on several early automobiles. Two electrodes, or contacts, were attached inside the cylinder head, one insulated and fixed, and the other one moveable and grounded. Electricity from a battery passed first through a simple electrical coil (that both created an electrical resistance and intensified the spark), then through the contacts to the ground and finally back to the battery to complete the circuit. When the two contacts were separated by some mechanical means (in Ford's case, a bolt attached to the top of the piston would strike the moveable contact just before the piston reached the top of its stroke), a spark occurred that ignited the fuel-air mixture within the cylinder.

This rough-but-ready solution to the ignition problem had one serious drawback. The timing of the ignition was fixed by the bolt on the piston at about 10 degrees before top dead center. The spark could not be retarded for starting the engine nor advanced to increase its speed. [In later development of the make-and-break system for stationary engines and early automobiles, the contacts were in the cylinder, but the mechanism for opening and closing the contacts were placed outside the cylinder. This allowed for a means for advancing and retarding the spark.] All in all, Henry Ford's primitive ignition system combined with its equally crude carburetor worked, but it severely restricted the performance and range of operation of the engine on his first car. A better system was needed. Fortunately for Henry Ford, he made the acquaintance of Edward S. Huff and was able to enlist him in Ford's automobile development work.

Amongst Henry Ford's many, early lieutenants, none was more talented in the field of electricity than Ed Huff. One early associate

recalled “Ed was quite a genius. He was a mechanical genius in putting things together. He had quite a yen for electricity and gears and things of that kind.” When it came to the problem of ignition “He was just the type of fellow who was needed on that job.”

In early 1902 while Ford was designing and building what would become the famous “999” race car, he delegated the task of designing of the ignition system to Ed Huff. Huff abandoned the make and break ignition system in favor of a “jump spark” system. The jump spark ignition system was not a new development, and in fact had been in use for nearly forty years. The Frenchman Lenoir, who is credited with building the first successful internal

combustion engine, used something like it in his engines as early as 1862.²

The jump spark system employed a spark plug, a commutator that timed the spark to the cylinder, a battery to serve as a source of current, and a vibrator coil. (See Photo 1). The theory of the vibrator coil was quite complex for the time. It consisted of two circuits of wires wound around an iron core. (See Photo 2). The primary circuit consisted of a number of turns of fairly heavy gauge wire. When current from the battery flowed through this circuit it served to turn the iron core into an electromagnet. The secondary circuit consisted of a very large number of turns of a very fine wire wrapped around the same iron core. This secondary circuit was connected to the spark plug. When the primary circuit was broken, the magnetic field around the iron core

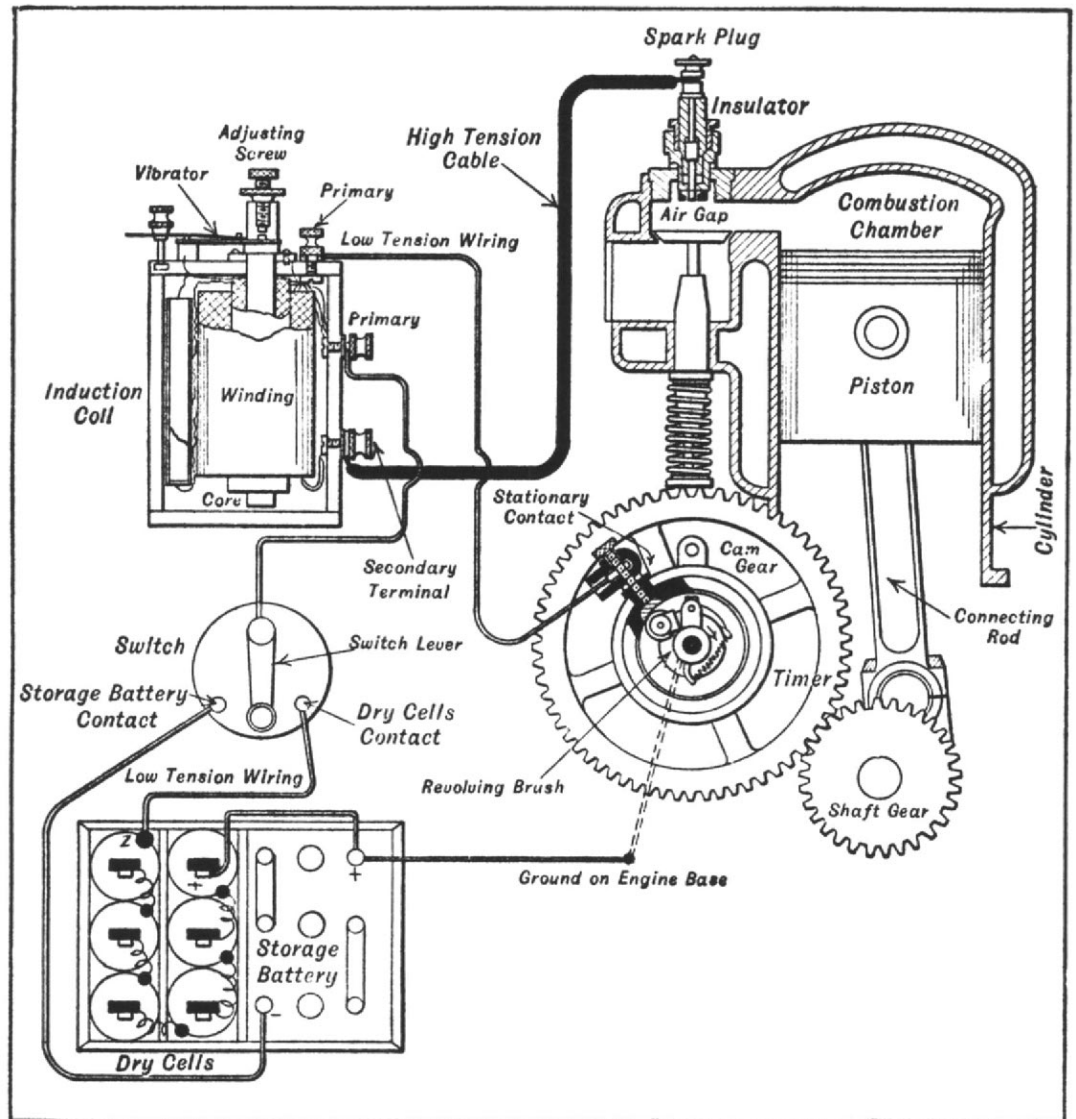

Photo 1: A simple vibrator coil ignition system showing the layout of the commutator, coil and wiring. Illustration from Victor Page The Model T Ford Car, 1917 Edition, Norman W. Henley Publishing Co, NY, 1917, p. 74.

collapsed, inducing an electrical current through the secondary circuit. Because of the large number of turns of wire in the secondary circuit, a very strong electrical voltage was induced in it. While brief, this high voltage was sufficient to jump across the gap between the electrodes of the spark plug and ignite the fuel-air mixture in the cylinder. The term vibrator coil arose from the use of two electrical contacts and a spring arrangement to close and open the circuit between the battery and the primary circuit. When the primary circuit was closed and the iron core was saturated with magnetism, the spring would be attracted towards the iron core, separating the contacts, and thus breaking the primary circuit. Once the contact was broken, the magnetic field collapsed, inducing a high voltage in the secondary circuit that would jump the gap at the spark

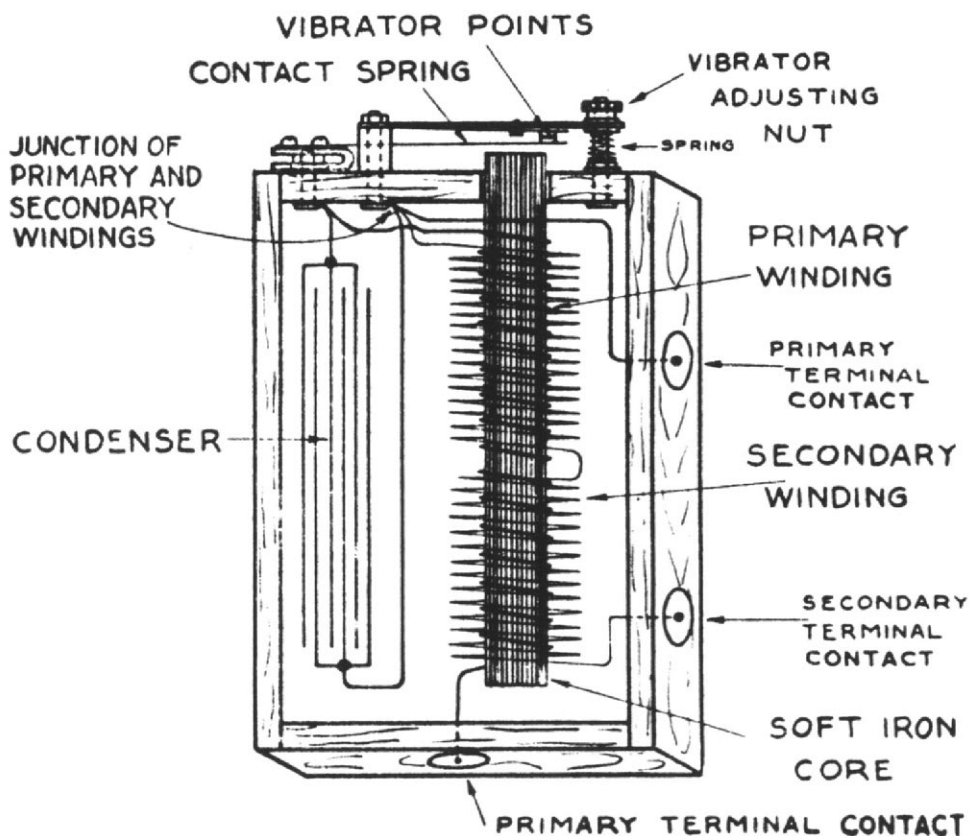

FIG. 184.—Ford (K-W) induction coil, showing typical three-terminal coil.

Photo 2: Schematic diagram of the K-W vibrator coil showing the primary and secondary circuits, the contact points and the condenser. Illustration from George W. Hobbs and Ben G. Elliott *The Gasoline Automobile*, 3rd Ed., McGraw-Hill Book Company, Inc, NY, 1924, p. 162.

plug. At the same time, the collapse of the magnetic field released the spring allowing the contacts to touch and reestablish the primary circuit and thereby start the entire process all over again. This continuous making and breaking of the contacts resulted in a vibration or buzzing of the coil and an accompanying stream of sparks.³

A vibrator coil and the “kick” coil used on the make and break ignition systems share a common component: a primary circuit wrapped around a soft iron core that becomes an electromagnet when current flows through it. In both cases when the circuit is broken, either by the separation of contacts in the make and break system or by the separation of the points of a vibrator coil, the magnetic field collapses through the windings of the primary circuit and induces a surge of voltage in that circuit as well. This surge of voltage can be 50 to 100 times greater than the voltage in the primary circuit before the circuit was broken. It is this surge that

produces the spark that enables the make and break ignition system to ignite the charge in the cylinder.

As in the case of the kick coil, a vibrator coil also tends to produce a spark between the contact points of the vibrator when the primary circuit is broken. This spark is undesirable for two reasons. First, it will cause the contacts between the vibrator to erode rapidly. Second, since current continues to flow through the primary circuit as the spark jumps between the point contact, the magnetic field in the iron core tends to collapse rather slowly. This in turn reduces the strength of the voltage induced in the secondary circuit.

In order to reduce the sparking between the contact points of the vibrator coil and

to quickly collapse the magnetic field, a condenser is used in the vibrator coil. A condenser is a device designed to absorb or store up a charge of electricity. At the beginning of the century, condensers were made of two sheets of tin foil separated from each other by sheets of paper coated in paraffin and rolled up to make the assembly a reasonable size. At the instant the contact points separate, the current flowing in the primary circuit begins to flow into one side of the condenser. This diverts the current and keeps it from jumping the gap between the points when they separate. As current flows into the condenser, the electrical potential on the one side of the condenser becomes much higher than the other side. This in turn causes a discharge back through the primary circuit in the opposite direction. The return flow of current out of the condenser very quickly dampens the current in the primary circuit, contributing to a rapid collapse of the magnetic field in the iron core and conse-

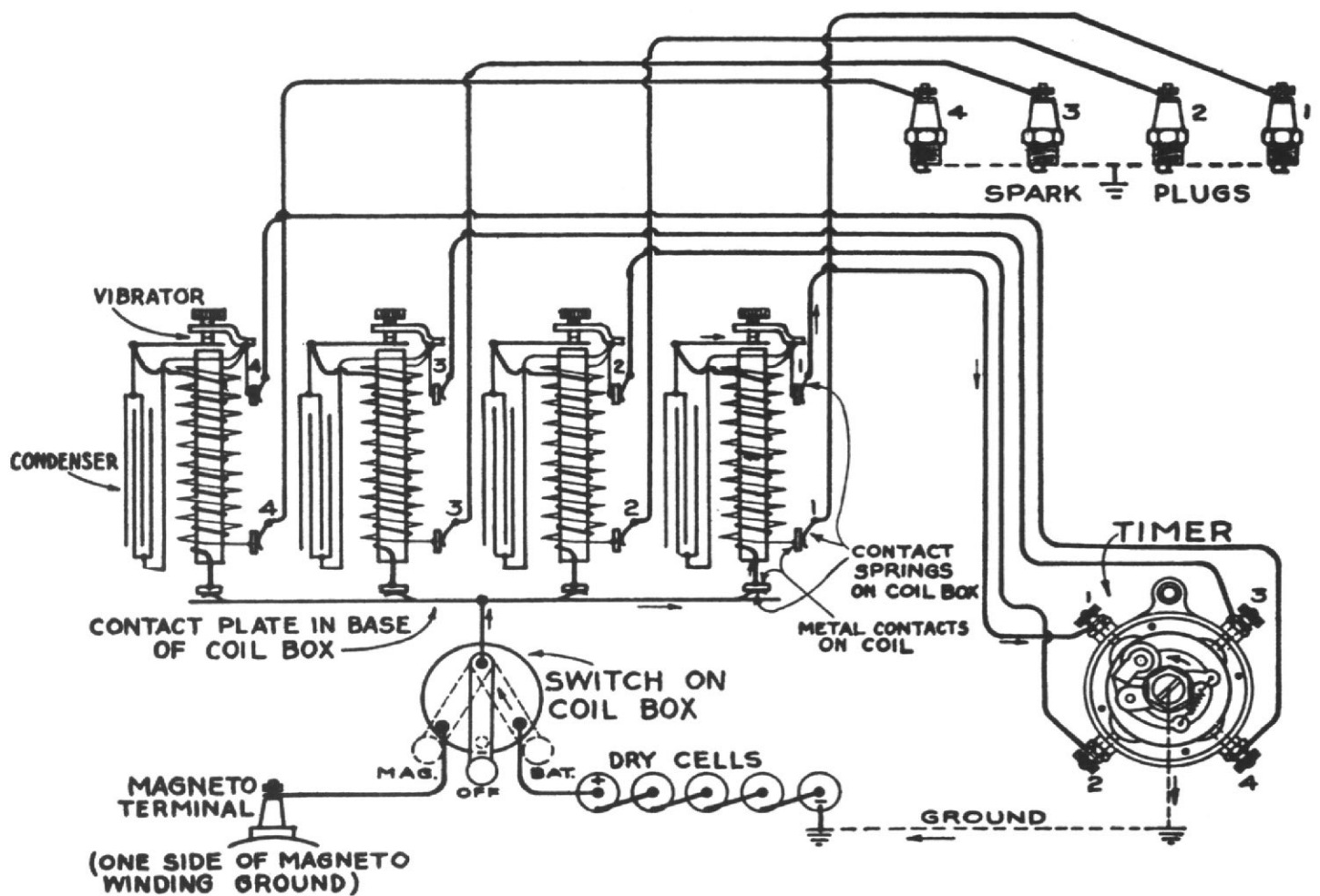

FIG. 186.—Diagram of four-cylinder vibrating-coil ignition system.

Photo 3: *Wiring diagram for a four-cylinder vibrator coil ignition system. Each cylinder requires a separate vibrator coil unit. Illustration from George W. Hobbs and Ben G. Elliott The Gasoline Automobile, 3rd Edition, McGraw-Hill Book Company, Inc, NY, 1924, p. 163.*

quently induces a much higher voltage in the secondary circuit.*

A vibrator coil will continue to produce a series of sparks so long as current is applied to the primary circuit. It is necessary to break the primary circuit in order to stop the sparks when they were not wanted. To accomplish this, a commutator or timer is used. The timer is operated by the engine and permits the closing and opening of the primary circuit from the battery or magneto to the coil. The closing of contact within the timer would allow current to flow through the primary circuit at the proper time, initiating the vibrating of the coil and the stream of sparks. The timer is adjustable so that the circuit could be connected earlier or later in relation to the position of the piston within the

cylinder, thus advancing or retarding the spark.

In multi-cylinder engines, the vibrator coil ignition system requires a separate spark plug, vibrator coil and circuit for each cylinder. (See Photo 3). The timer is usually driven by the engine's camshaft, which rotates once for every two revolutions of the crankshaft. The timer has a number of separate contacts, one for each cylinder. For the 999 race car, the biggest and most powerful engine that Ford had built up to that time, Ed Huff made a separate ignition coil for each cylinder. Each coil was placed in a wood box on the dash behind the engine with the vibrator extending out toward the back of the car. The primary circuit of each coil was wired in series to a bank of dry cell batteries and the timer. (See Photos 4 and 5) The success of the 999 race car

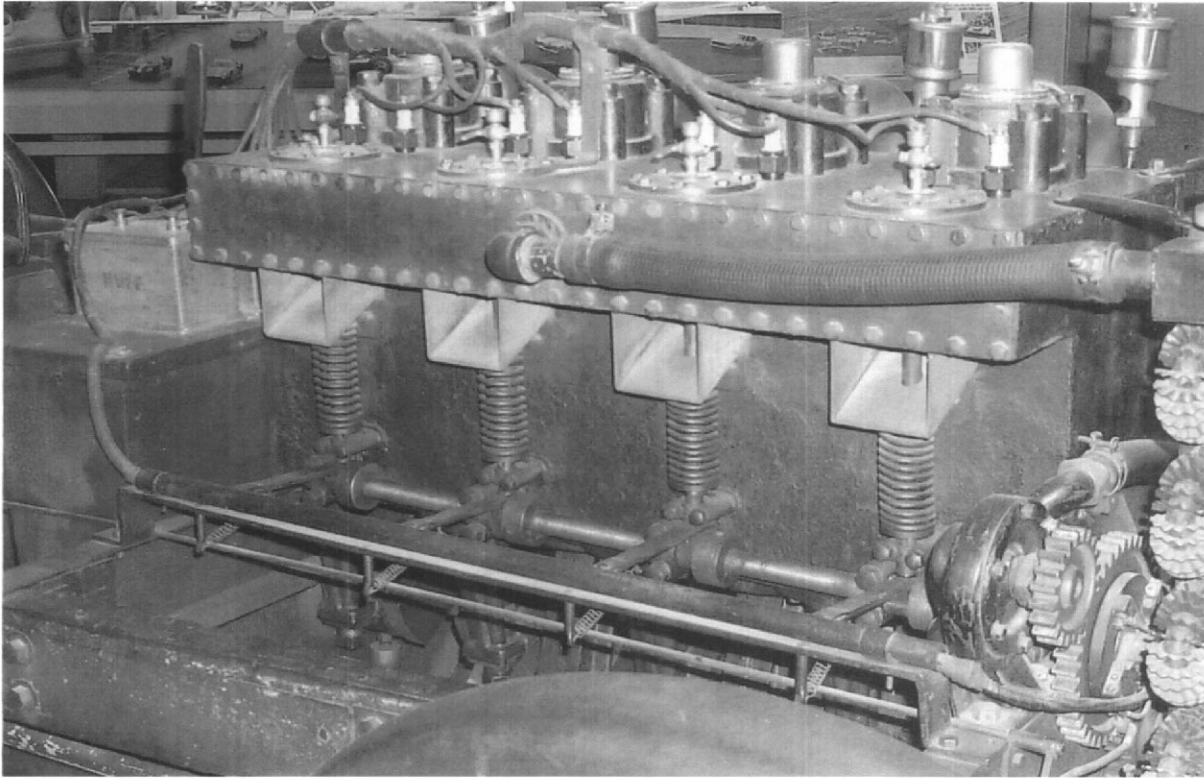
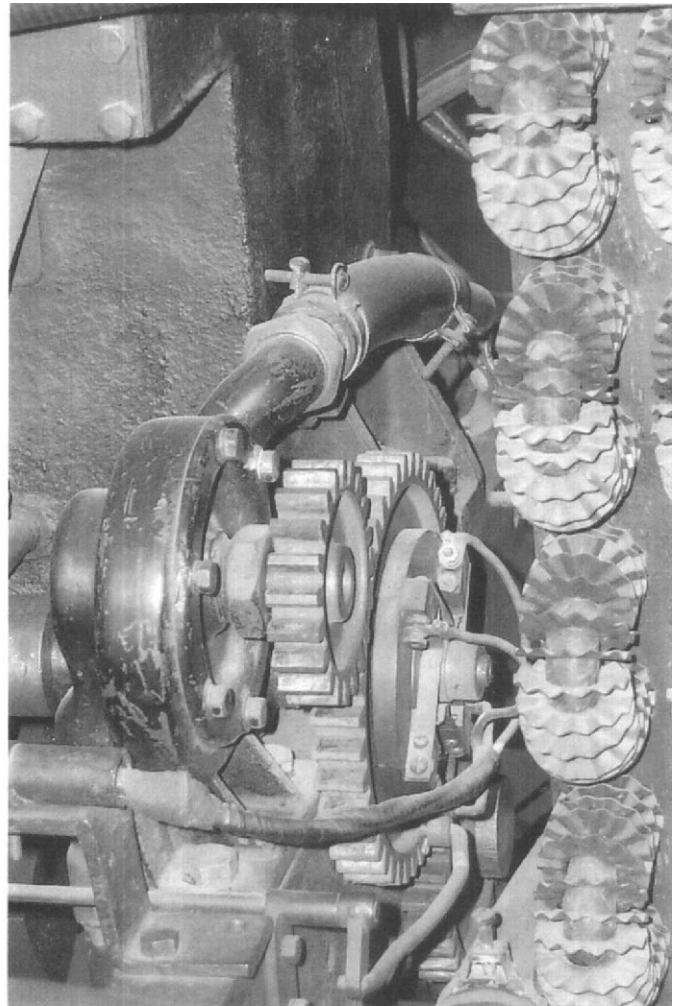

Photo 4 (above): The vibrator coil ignition system on Henry Ford's 1902 race car the "999." The timer is located at the front of the camshaft. The commutator wires are carried in a conduit along the right hand side of the engine to four separate vibrator coils mounted directly behind the engine. The high tension wires travel from the vibrator coils, across the top of the engine and split two the two separate sparkplugs used on each cylinder. These coils were made by Ed Huff and are so marked on the sides of each of them.

Photo 5 (right): A close up view of the timer on the "999" race car showing the four contacts, one for each cylinder. The small gear visible in the photograph drives the water circulating pump.



in late 1902 was due to its power and speed, which in part was attributable to the jump spark ignition system Huff had installed. When the Ford Motor Company was formed the following year and the Company's first products sent to market, they too employed the same type of jump spark ignition system that had proven so successful on the 999.

The 1903 Model A Fords used two-cylinder engines equipped with jump spark ignition systems patterned after the one used on the 999. While Ed Huff continued to assist in the research and design of the company's evolving products,

Ford turned to other companies to supply it with the ignition components for its cars. One of the first principle suppliers of spark plugs and vibrator coils was the Splitdorf Company of New York. Splitdorf was one of the best known of the early ignition system manufacturers. Its products, which included spark plugs and commutators as well as ignition coils, were used on many different brands of early automobiles as well as Ford. For the first three and a half years of the Ford Motor Company, Splitdorf coils were used almost exclusively on the Company's products. In addition to the Model A, they were used on the Models B, C, F and the famous Model N Ford of 1906.

During 1907 Ford made two important decisions that affect the ignition coil story. First, Ford decided to begin buying vibrator coils from a second firm and installing them on the Company's two newest Models, the R and the S. The new coil supplier was the Heinze Electrical Company of Lowell, Massachusetts. The exact reason for taking on this new vendor is not known, but according to Ford's financial records, after March 1907 Heinze began taking a larger and larger portion of the Company's coil business, and purchases from Splitdorf dwindled over the next 18 months.⁵

A second and more significant decision was



Simplicity is the Strong Point of the K-W Magneto

IT is the simplest piece of mechanism that could possibly be conceived. In place of the moving wires, brushes, traps and triggers of the average Magneto, the K-W Magneto has only one moving part which runs in the highest grade of ball bearings. The magnetism of the K-W Magneto will last forever.

❏ You don't need batteries of any kind when you have a K-W Magneto as we guarantee that **the K-W Magneto will start any engine without batteries** and run it perfectly at all speeds from the lowest to the very highest, provided a K-W Coil is used with it or a K-W Master Vibrator is used with the old coil.

❏ The difference in models A, B and F Magnetos is merely for convenience in attaching to the engine as the work they will do is the same. This also applies to model A-L, B-L and F-L. They can be mounted in any position and run in either direction. The speed is four or five times crank shaft speed. Wire them up just like a set of batteries.



Model A, for Ignition only, \$35.
Model A-L, for combined Ignition and Lighting or Lighting only, \$50.
Belt drive or gear drive. Jump spark. Very simple and efficient. Makes you throw your batteries away.



Model B, for Ignition only, \$35.00
Model B-L, for combined Ignition and Lighting or Lighting only, \$50.00
Friction drive and will not slip. A standard for good ignition and can not be beaten.



Model F, for Ignition only, \$35.
Model F-L, for combined Ignition and Lighting or Lighting only, \$50
Belt drive. Has bracket for attaching to frame of car. Good on any automobile.



Model C, for Ignition only, \$45.
Model C-L, for combined Ignition and Lighting, or Lighting only, \$60.
Just like model A, except has one extra magnet and is much stronger and intended for the heaviest engines.



"THE MOTOR BOAT SPECIAL"
Model M, for Ignition only, \$35.00
Model M-L, for combined Ignition and Lighting or Lighting only, \$50.00
Runs in either direction and two cycle engines can be reversed on it. Makes you throw your batteries overboard.



HIGH TENSION
Gear driven at engine speed. A complete ignition system, nothing else needed but the spark plugs. Absolutely no coil of any kind used. The most perfect ignition system in the world. Guaranteed to start any engine easily on the first quarter turn of the crank and save 25% of the gasoline.
Will not run lights.

For Make-and-Break Spark
Model A-M for engines under 30 h. p. \$35.00
Model C-M for engines over 30 h. p. \$45.00
Just like models A and C, except has a different winding for Make-and-Break. Must be Gear driven. No coil is needed. Engine can easily be started on it. The best Magneto for Make-and-Break spark. Does not furnish lights.



The K-W Spark Plug, \$1.00 postpaid
Six for \$5.00
No packing is used, but accurate joints positively prevent leaking of compression. A spring at the end takes up the heat expansion and effectually prevents cracked porcelains. Soot proof and will not short circuit. The more plugs of other makes you have tried, the better you will like this one. If your dealer does not handle it, send direct to us. Take no substitute.

Model H 4 Magnets	Model HT- 5 Magnets
2, 3 and 4 cylinder \$ 75.00	\$100.00
6 cylinder 85.00	110.00
Say whether for two or four cycle.	
Model O, for 2-cylinder opposed.	
Has no distributor \$50.00.	

Photo 6: Illustration of magnetos supplied by the K-W Ignition Company from their 1910 catalog. The Model F seems to have been intended for the Models N, R and S Ford.

From the collections of Henry Ford Museum & Greenfield Village

made when Henry Ford concluded that his lower priced cars needed to be able to produce their own electricity for ignition instead of relying exclusively on batteries for current. Most of Ford's early models had relied on batteries to

supply the power for the ignition system. For example, the two-cylinder Models A, C and F, and the four-cylinder Model N each came equipped with two banks of six dry cell batteries. Six new dry cells was considered to be sufficient to run the car continuously for about 100 to 200 miles. Two banks were used so that when the first bank began to run down, the driver could switch over to the second set or reserve set until either the trip was completed or the driver could purchase a new set of batteries. Even with two sets of batteries, it was common in that time period to see cars pulled off the side of the road because the batteries were dead.⁶

The new Models R and S for 1907 attempted to alleviate this problem somewhat by replacing one of the banks of dry cells with a wet cell storage battery. The initial cost of a storage battery was higher than a set of dry cells, but the

storage battery could be removed and recharged many times while dry cells had to be replaced when they ran down.

Ford recognized that the ultimate solution was to equip the cars with a dynamo or magneto that would continuously generate the electrical power for ignition. The storage battery or dry cells could then be saved for starting the car. Once started the dynamo or magneto would supply the current for keeping the car running. At the time the decision to adopt a magneto was made Henry Ford was in the midst of designing a new car to replace the Models N, R and S. It appears that it was in fact Henry Ford's own idea to attach a magneto to the flywheel of the new model and he assigned the task of designing the flywheel magneto of the future Model T to the able Ed Huff.⁷ In the meantime, Henry Ford seems to have seriously considered adding on a

GET A
K=W MAGNETO

For Your Ford Runabout and
Throw Your Batteries Away

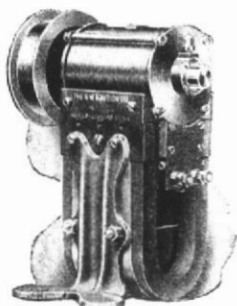

Price \$35.00

MODEL F. Made especially for Ford Runabouts but is good on any car. It will start any engine that can be turned over by hand, easily, without batteries, and will run it faster and better than any battery with more power and less fuel because it gives a hotter spark than any battery.

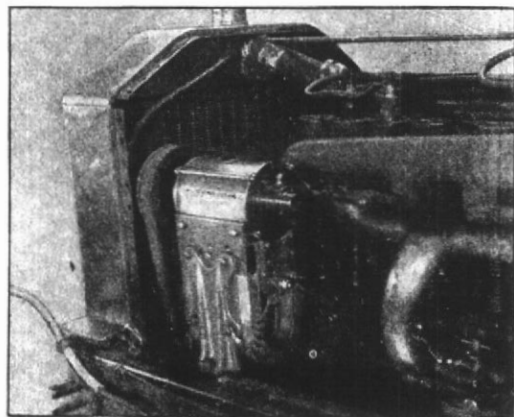

This cut shows how easily the K-W Magneto can be mounted by simply bolting to the frame of the car. Waterproof and stretchproof belt and fasteners. \$1.00.

The K-W Master Vibrator used in connection with the K-W Magneto will give you the very best ignition system possible to obtain at any price. The results will surprise you. Give it a trial.

We make eight Models of K-W Magnetos in belt, friction and gear drive for jump spark and make-and-break, and we also make K-W Plugs and K-W Coils.

Our Bulletin No. 8 describes all. Write today.

The K=W Ignition Co.

32 Power Avenue, CLEVELAND, OHIO

AGENTS:

NEW YORK REPRESENTATIVES: A. H. Green & Co., 1686 Broadway, New York City.
BOSTON REPRESENTATIVE: W. J. Forbes, 220 Congress Street, Boston, Massachusetts.
DETROIT REPRESENTATIVE: Hale C. Barber, 327 Jefferson Avenue.

Photo 7: Advertisement for K-W Ignition Company's Model F magneto for the Models N, R and S Fords.

All of the hardware and brackets necessary to adapt this magneto to the Ford seems to have been designed by the engineers at the Ford Motor Company.

Illustration from Horseless Age, Vol. 22, No. 13 (September 23, 1908) p. 38.

From the collections of Henry Ford Museum & Greenfield Village

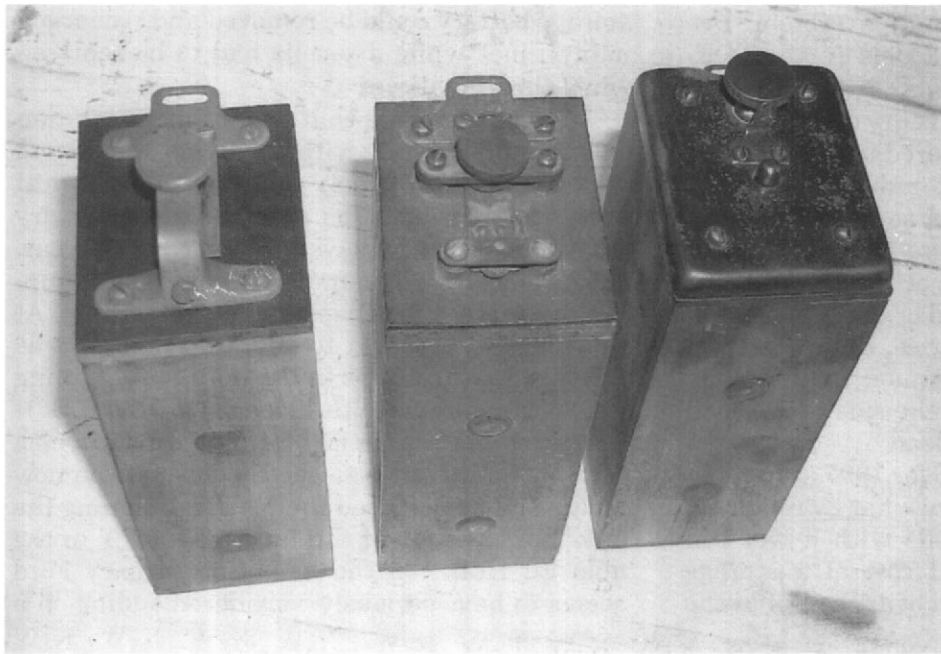
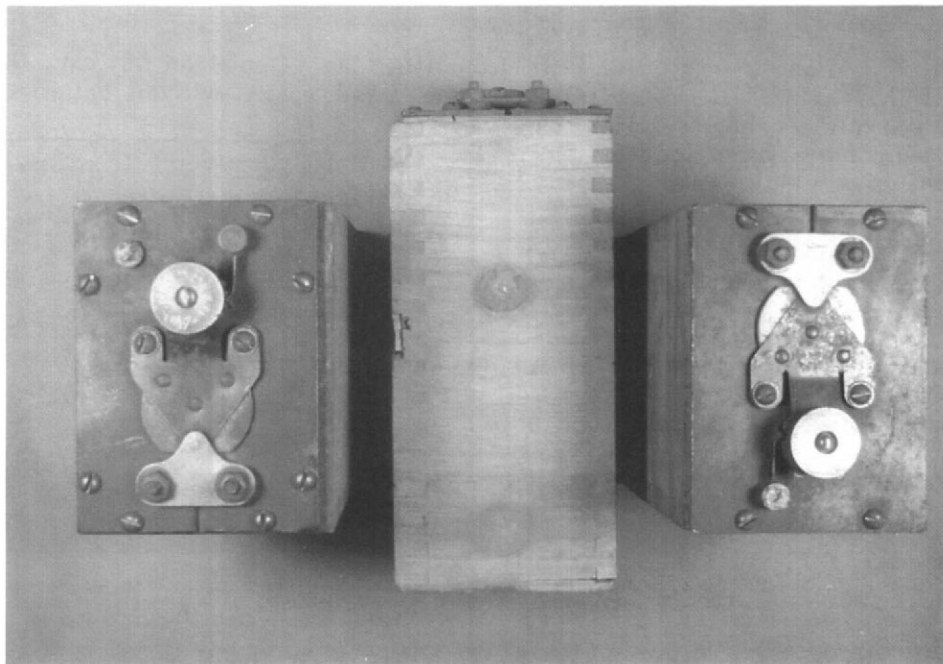

Photo 8: Kingston Coil used on the Model T from 1909-1912. From left to right, the 1909-10 Kingston Coil, the 1911 coil and a Kingston coil used for a short time in 1912. This last coil is easily identifiable by its metal top covering the points.

Photo 9: Heinze coils used on the Model From 1909 to 1913. The coils whose tops are held to the box by eight brass headed screws appear to have been used from 1909 to 1911. It is believed that in 1912 the number of screws holding the top to the box decreased from eight to four.



dynamo to the Models N, R, and S cars. This dynamo was to be located on the left-hand side of the engine and was to be powered by a belt from the engine flywheel to the dynamo. To supply this dynamo Ford turned to a little known

electrical company in Cleveland, Ohio: the K-W Ignition Company.

Relatively little is known about the early years of the K-W Ignition Company. The Cleveland City Directory for 1908 lists the K-W Ignition Company's address as being the Whitney Building. Its officers were Joseph A. Williams, president; William Kaple, vice-president; and, A. F. Williams, secretary. It is almost certain that the company's name was derived from the names of these two principle officers: Kaple and Williams.⁸

A 1910 K-W Ignition Company catalog describes the company's product line. It included electric headlights, spark coils and magnetos. It was the company's Model F magneto that appears to have attracted the attention of Henry Ford. (See Photo 6). This magneto was really an alternator or dynamo that was driven by a belt from the automobile engine's flywheel. The power generated by the magneto was then used to supply the stock ignition coils of the car. K-W advertised that this magneto was so powerful that it was actually guaranteed to start any engine without the use of batteries.⁹

Evidence that Ford gave serious consideration to adopting the K-W magneto can be found on original Model N factory drawings. A complete set of drawings was made by Ford draftsmen during late 1907 for all of the parts necessary to attach the K-W magneto to the engine of the Models N, R and S Fords."

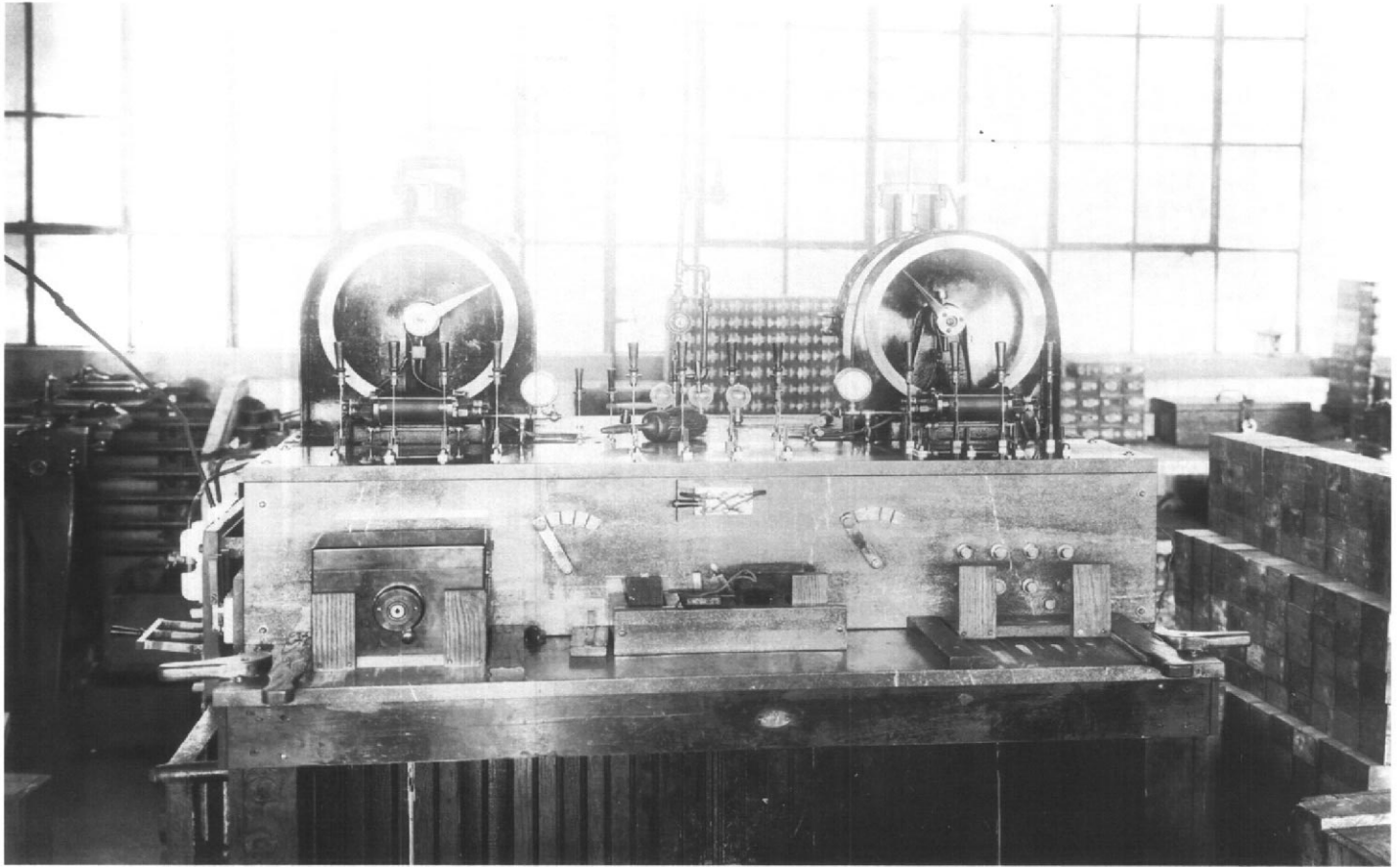

Photo 10: *Adjusting Model T Coils at the Highland Park plant ca. 1911. A Heinze coil unit is in the test bed on the left. The large stack of coils on the right hand side appear to be individual Heinze coil units. Stacked against the window in the background are appear to be Kingston coil units.*

From the Collections of the Henry Ford Museum & Greenfield Village. Neg no. P.O-8502.

Although a complete set of drawings for attaching the K-W magneto were made, it does not appear that Ford ever offered the K-W magneto either as standard equipment or a factory authorized accessory on the Models N, R, and S Fords. Perhaps Henry Ford concluded that Huffs progress on the flywheel magneto for the Model T would soon make the N, R and S models obsolete along with ancillary magnetos. In any case, this first business relationship with the K-W Ignition Company quickly ended. However, the following year, 1908, K-W placed advertisements in *Horseless Age* and other early automobile trade journals displaying the specially designed unit and offering it for sale. (See Photo 7).

On October 1, 1908 the Model T Ford was introduced. It used an ignition system patterned after that used in the earlier Models N, R and S. While the locations of some of the components were changed as well as the method of wiring, it remained an ignition system based on vibrator coils and a commutator. The major innovation

was the use of the flywheel magneto. This virtually maintenance-free electric dynamo provided sufficient alternating current to operate the coils. On well-tuned Model Ts, the car would start on the magneto and the use of a battery could be dispensed with altogether.

Along with the new model came a new ignition coil supplier. The new vendor was the Kokomo Electric Company of Kokomo, Indiana who supplied ignition coils under the trade name Kingston." A bit later in 1909 Heinze resumed coil sales to Ford and a substantial portion of the late 1909 production came so equipped.¹² (See Photos 8 and 9).

While the flywheel magneto seems to have solved the problem of a source of current for the ignition coils, there is also some evidence that it created new problems. Letters and other documents in the collections of the Research Center indicate that during 1910 Ford began looking at other coil maker's products and consulting with outside engineers on the coil issue. This may have led to Ford taking on a third supplier of

coils, the Jacobson and Brandow firm of Pittsfield, Massachusetts. (See Photo 11).

As nearly as can be determined at this time the problem involved the synchronization of the four coil units. Synchronization refers to the timing of the high-tension spark from each of the coils. Ideally, each coil will send a high voltage jolt to its respective sparkplug at the same relative point of crankshaft rotation and piston travel. Ignition of each cylinder at the same relative point will tend to promote a smooth running engine. However, synchronizing four different vibrator coil units so that each will send its spark at the proper moment is a bit problematic.

The reason for this arises from the theory of the vibrator coil. Recall that current flowing through the primary windings of the coil turns the iron core into an electromagnet. The magnetic field from this core in turn attracts a steel spring which is making contact to complete the primary circuit. When the contact brakes, current stops flowing through the primary circuit, the magnetic field collapses, inducing a high voltage through the secondary circuit connected



Photo 11: *Jacobson and Brandow coils used in 1910, 1911 and 1912.
The taller of the two coils was used in 1910 and 1911.
The shorter coil saw limited use in 1912.*

to the spark plug. The nature of this design makes the breaking of the contact and the induction of the high voltage in the secondary circuit sensitive to the voltage applied to the primary circuit. Moreover, variations in the tension of the contact spring and its distance from the iron core of the magnet can greatly effect the amount of current that is required to attract the spring, break the contact, and induce the spark.

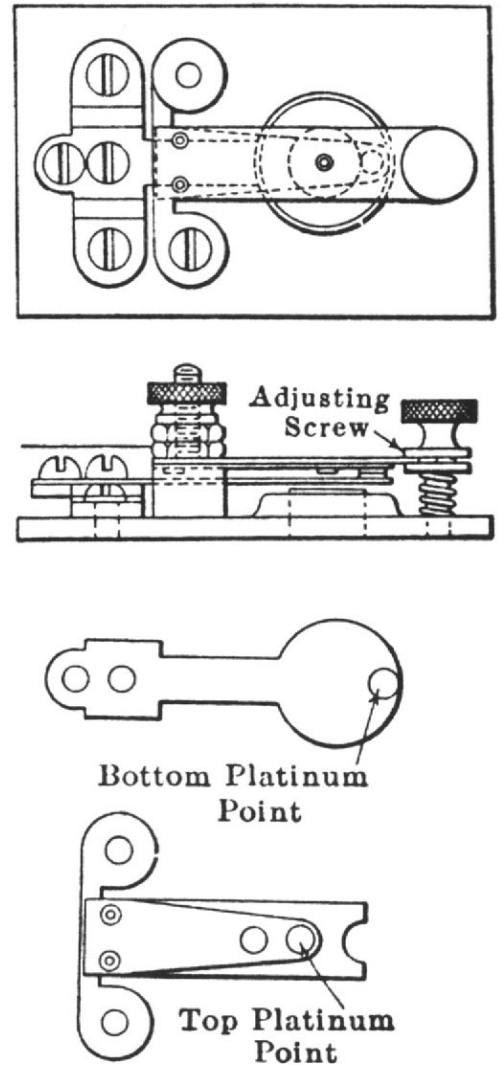
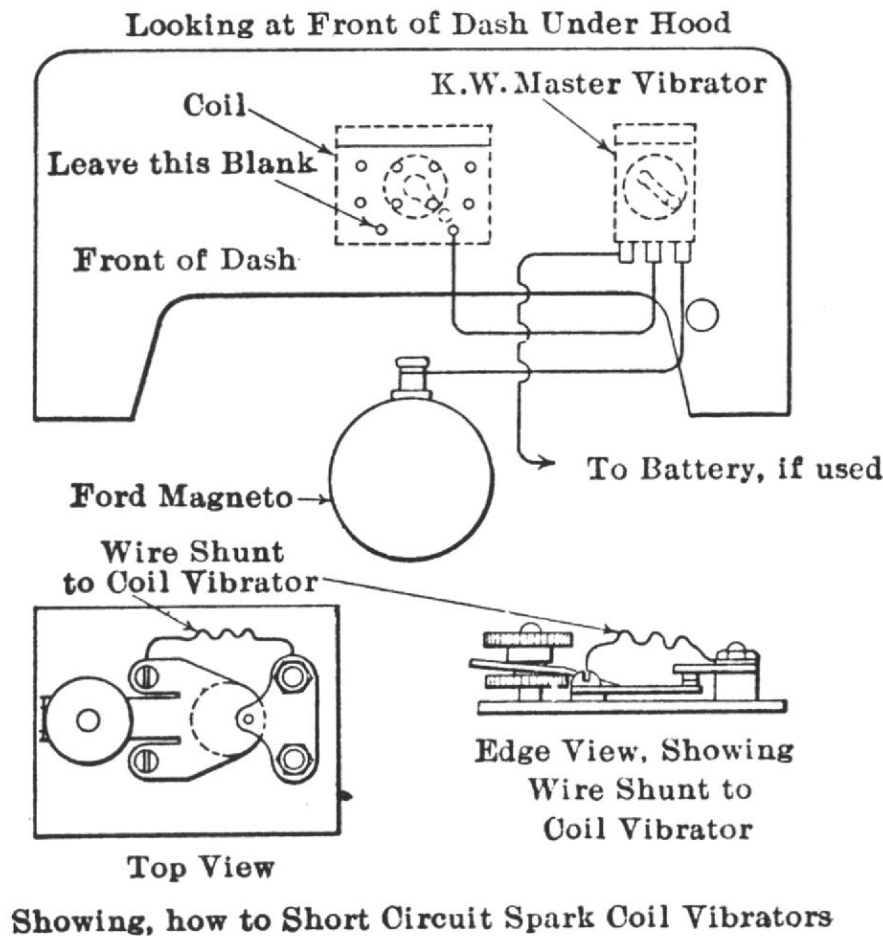

Photo 12: *Wiring diagram for a K-W Master Vibrator Coil. The points on the regular ignition coils were shorted out and the points on the master vibrator operated the four individual coil units. Illustration from Victor Page The Model T Ford Car, 1917 Edition, Norman W. Henley Publishing Co., Brooklyn, NY, P. 85.*

In a battery powered ignition system the voltage supplied to the primary circuit of the ignition coil is constant. Since each coil receives the same amount of voltage when the commutator makes contact, each coil will in turn send a high voltage surge to the spark plug almost instantly afterward. As long as the contacts in the commutator are properly arranged, synchronization will not be a great problem.. However, the Model T flywheel magneto produces an alternating current ranging from six to twenty-eight volts. This current occurs in the pattern of a sine wave that repeats itself 8 times over the course of one revolution of the crankshaft. Starting with the magnets on the flywheel located midway between two coils on the magneto coil ring, the voltage will be zero. As the magnets approach and pass over the center of the magneto coil, the

voltage will rise and reach a peak. As the magnets pass the center of the coils and rotate towards the midpoint between them again, the voltage will fall back towards zero. As the magnets continue their rotation the cycle will repeat itself, although with the current flowing in the opposite direction.

The performance of vibrator coils tends to vary somewhat from coil to coil. This performance is affected by the tension in the contact spring and its distance from the iron electromagnet core of the coil. When the tension of the vibrators and their distance from the core differ, then one vibrator coil may require a different threshold voltage level to produce a spark than another. That is, four volts may be sufficient for one coil to begin to produce its stream of high voltage sparks while a second may require five

Photo 13 (opposite top): *Front view of a 1912 Kingston coil assembly incorporating a master vibrator coil in its design. The master vibrator is the middle unit in the coil. The other four are slaves. This box used the standard Kingston switch and latches for the top.*

Photo 14 (opposite bottom): *Rear view of the special 1912 Kingston coil assembly. Note the clever way Kingston modified the back of this box so that it would fit the standard Ford dash. The commutator and high tension terminals for the second and third coils and the magneto and battery terminals are attached to brass contacts that shift the terminal posts in toward the center of the box.*

and a halfvolts before it begins to emit its stream of sparks. Since the voltage level produced by the flywheel magneto varies with the rotation of the crankshaft, this means that different vibrator coils would send a spark to its plug at a different relative point in crankshaft rotation and travel of the piston in the cylinder. For example, the first coil might send a spark at fifteen degrees of crankshaft rotation before the piston reached top dead center, the second might do so at thirteen degrees, the third at seventeen degrees, and the fourth at sixteen degrees. Since each cylinder will be firing at a slightly different point, the power produced in each cylinder will also be different. This tends to result in a rather rough-running engine.

One solution to the coil synchronization problem was the use of a "master vibrator" coil.

This is a specially built coil unit that is used in conjunction with the regular factory issued coils on the car. The principle behind the master vibrator coil is quite simple. The regular vibrator points on the factory issued coils were disabled and the master vibrator coil was wired into the circuit so that the points and primary circuit on the master would operate the primary circuits on each of the factory issued coils. With only the one set of points on the primary circuit of the master coil operating, it insured that coils for each separate cylinder would send a spark to the plug at the same relative point of crankshaft rotation and piston travel. With each cylinder receiving its ignition spark at the same point, power was equalized between the cylinders and a much smoother running engine was achieved. Master vibrator coils were manufactured and sold by many early automotive ignition companies including Jacobson and Brandow and K-W Ignition. (See Photo 12).

Ford resisted the master vibrator coil solution. Instead, Kingston and Heinze continued to make improvements in the designs of their coils to alleviate the problem. As stated above, the Jacobson and Brandow coils were adopted as standard equipment on many Model Ts because it was thought that the design of their points tended to reduce the synchronization problem. The problem persisted for several years, and during 1912 Ford even tried a modified Kingston design that included a master vibrator coil and four slaves all in the same box mounted on the dash. However, this Kingston design soon proved not to resolve the problem to Ford's satisfaction and all outstanding Kingston coils of this design were recalled and replaced by the factory.¹³ (See Photos 13 and 14) □

The authors may be contacted by writing:
Trent E. Boggess
Department of Business
Plymouth State College
Plymouth, NH 03264
e-mail: Trentb@oz.plymouth.edu

Ronald Patterson
8 Olde Surrey Lane
Medway, MA 02053
e-mail: Modeltcoils@sprynet.com

Footnotes

¹ Reminiscences of William W. Pring, Accession 65, Research Center, Henry Ford Museum and Greenfield Village. p. 8. (Hereafter cited as Research Center).

² Charles E. Duryea, *Automobiles: Instruction Paper*, American School of Correspondence, Chicago, 1906, p. 68.

³ *Ibid.*, p. 70.

⁴ Frank D. Graham, *Audels New Automobile Guide for Mechanics, Operators and Servicemen*, Theo. Audel & Co., New York, 1943, pp.1902-1904.

⁵ Ford Motor Company Accounts Payable Ledger, Accession 623, Research Center.

⁶ Reminiscences of James Purdie, Accession 65, Research Center, pp. 66-67.

⁷ In their Reminiscences, both H.L. Maher and James Purdie give full credit for the idea of the flywheel magneto to Henry Ford, Accession 65, Research Center. See also "Henry Ford, Ed Huff and the Flywheel Magento", *The Vintage Ford*, Vol. 31, #2 (March-April 1996), pp. 20-33.

⁸ *The Cleveland Directory for the Year Ending 1908*, Cleveland Directory Company, Cleveland, Ohio, 1907, p. 786.

⁹ K-W, The K-W Ignition Company, Cleveland, Ohio, 1910. An original copy of this catalog can be found in the Trade Catalog collection at the Research Center.

¹⁰ Drawings for N-543, Acc. 1701, Research Center.

¹¹ Advertisement for K-W Ignition Co.'s Magneto, *Horseless Age*, Vol. 22, # 13, (September 23, 1908), p. 38.

¹² Documentation for the use of these coils can be found in the shipping invoices for the Model T 1909-1911, Accession 641, Boxes 1 and 2, Research Center.

¹³ Factory Letter for November 6, 1912, Accession 509, Research Center.

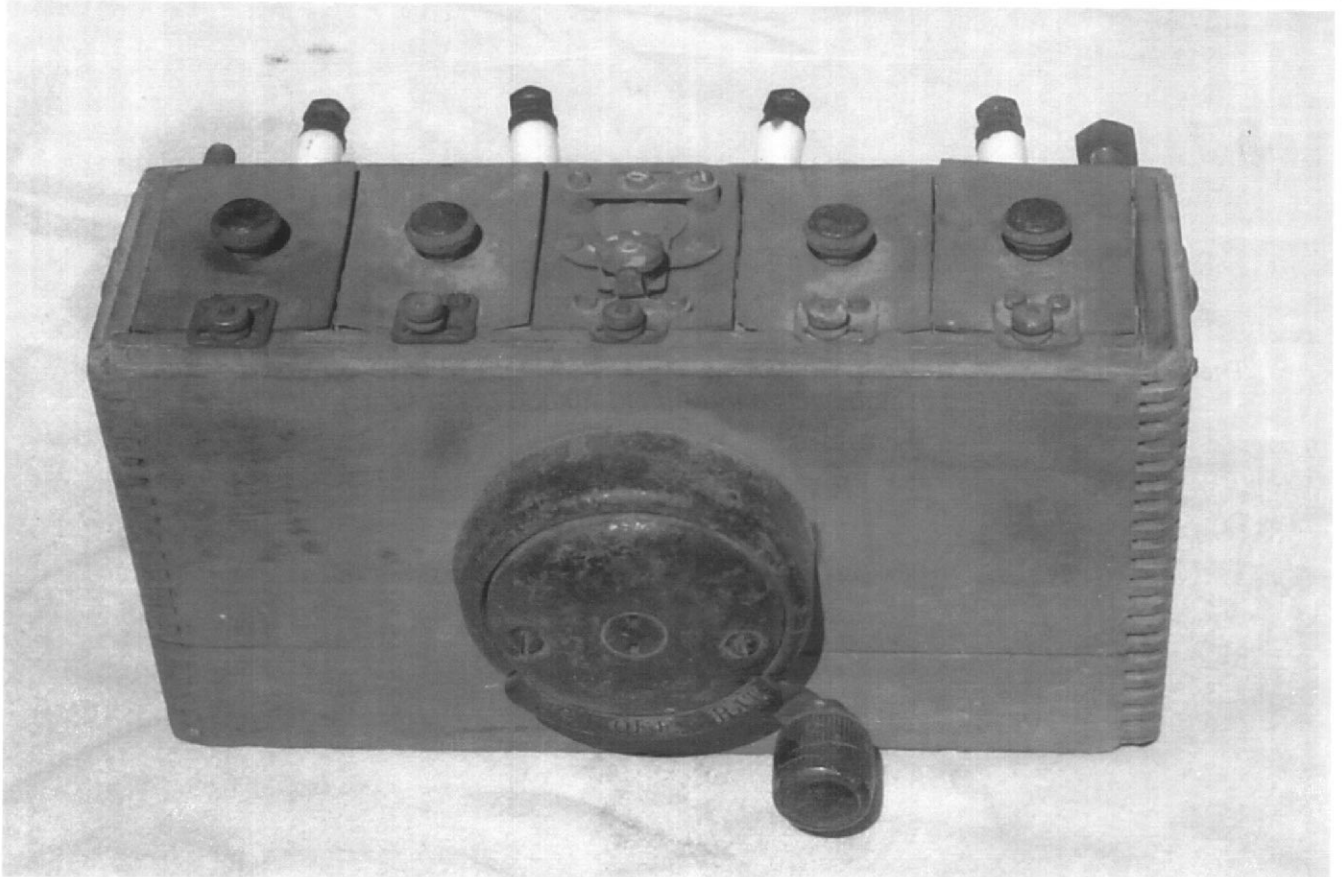
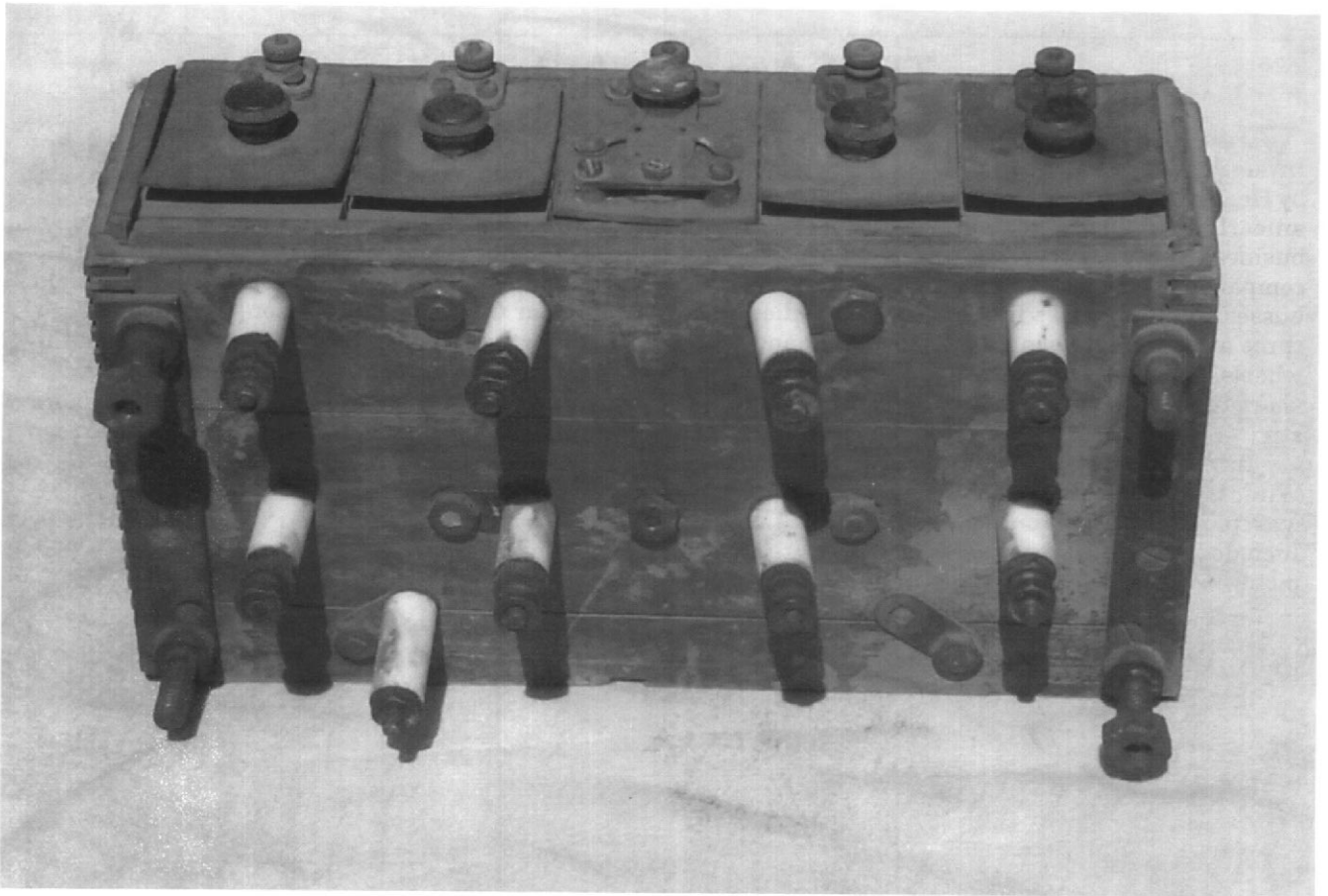

The Model T Ignition Coil

Part 2: The Ford Motor and K-W Ignition Companies

By Trent E. Boggess and Ronald Patterson

“Be it known that I, Joseph A. Williams, a citizen of the United States, residing at Cleveland, in the county of Cuyahoga and State of Ohio, have invented a certain new and useful Improvement in Ignition Apparatus...”

- U.S. Patent # 1,092,417

In 1907 the K-W Ignition Company of Cleveland, Ohio had attempted to persuade the Ford Motor Company to adopt their magneto for the Ford Models N, R and S. Although K-W's attempt was unsuccessful, it appears that Joseph A. Williams, president of K-W, continued to look for opportunities to hitch K-W Ignition Company's wagon to Ford Motor's rising star.

The association between K-W Ignition and the Ford Motor Company was resumed in late 1912. After its failure to get Ford to adopt the K-W magneto for its Models N, R and S cars, K-W continued to refine the design of its ignition coils as well as developing a line of accessories for the Model T. Ford Motor Company sales records in the Research Center at the Henry Ford Museum show that K-W purchased from Ford Motor Company a number of items that could have been used in K-W's product development program. These items included flywheel magnetos, a complete Model T motor, and a jig for testing coil units. The K-W product line also included “road smoothers” for Model T Fords and a magneto powered electric headlights and sidelights.

Sometime in the fall of 1912 Joseph Williams, President of K-W Ignition was in Detroit negotiating for advertising space in the Ford Motor Company's publication the Ford Times. During this meeting Williams told Ford representatives of his newest design of coil. He claimed that the new coil gave much better results in synchronizing the cylinders and eliminated the need for a master vibrator. Williams left Detroit with the advertisement placed and an appointment to meet with the Ford engineers to discuss and test Williams' coil. The tests appear to have satisfied the Ford engineers that Williams' claims were true, and soon thereafter Ford began using K-W coils on part of its regular production. (See Photo 1)

1913

Here is the Making of
A Merry Christmas
For Any Ford Owner

Master Vibrator
\$15.00

For all cars using vibrating spark coils and ESPECIALLY FOR Ford Cars

You will never know how much speed, power and flexibility there is in your car until you try a K-W Master Vibrator. It takes the place of the separate vibrators on your coil, giving you one fast vibrator and powerful condenser for all of them, thus giving absolute synchronism, with a smoother running engine and More Power.

Try it 30 days: if for any reason you don't want it, return it and get your money back.

PRICE, \$15.00
Express paid anywhere if cash accompanies order.

Electric Headlight Outfit, \$15.00

Not makeshifts, but are complete in every detail, designed and engineered to work in connection with the ignition, both deriving their supply of current from the Ford Magneto. The outfit complete, which is all you need, consists of: 1 pair complete 8" Head Lamps with Parabolic Reflectors with 1 1/2" focus. 2 Tungsten Bulbs, size 2 1/2" diameter. 12 feet Wire, all soldered to lamps. 1 Diamond Switch. Instruction Sheet for Wiring. The best results in electric lighting cannot be obtained by the use of reflectors put in gas lamps. The highly burnished silvered surface must be protected in a dust-proof lamp. The Reflectors have a 1 1/2" focus which throws a strong beam ahead as well as lighting both sides of the road brightly. The Lamps are made entirely of one piece of brass, drawn from steel dies, have no soldered joints, easy to polish, and are 8" over all, making a handsome lamp for the Ford cars. They fit the forks furnished on the Ford cars. The Light which this outfit gives is vastly superior to either a generator or gas lamp. The Bulbs have a Tungsten filament of the proper voltage and amperage which will not interfere with the ignition and have the Edi-Swan or Bayonet base, impossible to fall out and injure the silver reflector like the screw base. The price for complete outfit is \$15.00. We pay the express charges East of the Mississippi, and to the Mississippi on points beyond when cash accompanies the order.

Special outfit DeLuxe with nine-inch Bullet-Shaped Lamps \$20

We also make High-Tension Magnets, Low-Tension Magnets, and Vibrating Spark Coils—a complete line of ignition apparatus. Tell us you want when writing for catalogue.

FACTORY AND MAIN OFFICE:
THE K-W IGNITION CO.
40 Power Ave. CLEVELAND, OHIO, U.S.A.

Photo 1: A K-W Ignition Company advertisement published in the Ford Times in 1913.

The coils that K-W supplied Ford during early 1913 and perhaps late 1912 are easily distinguishable from later Model T coils. They are larger in size than later Model T coils and the locations of the three contacts on the coil units are also different. Finally, these coils have a flat brass top that with a black anodized finish (See Photos 2, 3 and 4) Four of these units were installed in a finished wooden box outfitted with the characteristic triangle-shaped K-W switch. (See Photo 5).

With the adoption of ignition coils manufactured by the K-W Ignition Company in late 1912 or early 1913 the Ford Motor Company began a business relationship with K-W that would last almost fifteen years. While both companies prospered during the tenure of the relationship, there were times when difficulties arose between them. The most serious difficulty arose over Joseph Williams' patent on the design of the K-W coil. Here is what is known of the story.

During the first half of 1913 Ford continued to use coils produced by Heinze, and perhaps by Kingston, as well as the K-W coils. By this time Ford had used six or seven different and non-interchangeable coils in the four years Model Ts had been in production. In order to avoid the confusion that resulted from using so many different coil units, to achieve production cost economies, and to reduce the different styles of coil boxes and coils that Ford dealers would have to carry in stock, Ford decided to standardize its coils. The standardization began with the Ford engineers specifying

Bottom (Photo 2): *A 1913 vintage K-W Ignition Company coil. It is easily distinguished by the flat, black anodized brass fop.*

Top Right (Photo 3): *A side by side comparison of the fops of the 1913 KW and the later brass fop style coils. The 1913 style coil's fop is a flat piece of brass while the later style brass fop is embossed to raise the height about 1/8 inch.*

Bottom Right (Photo 4): *A comparison of the location of the contacts on the 1913 K-W coil with a later K-W coil. The 1913 coil's side contacts are lower and the bottom contact is located near the rear edge of the box. The coil unit itself is thicker than the later standard coils.*

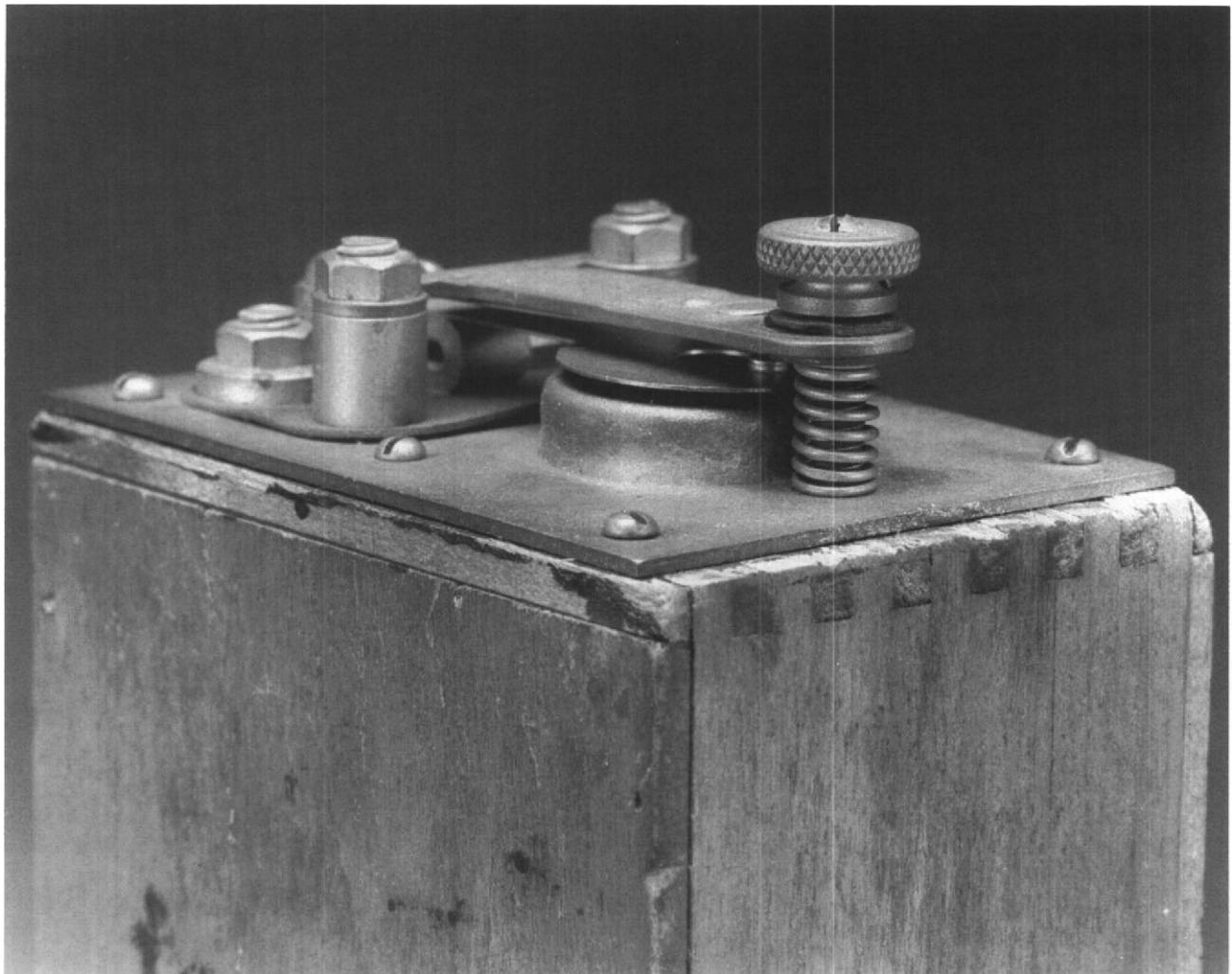

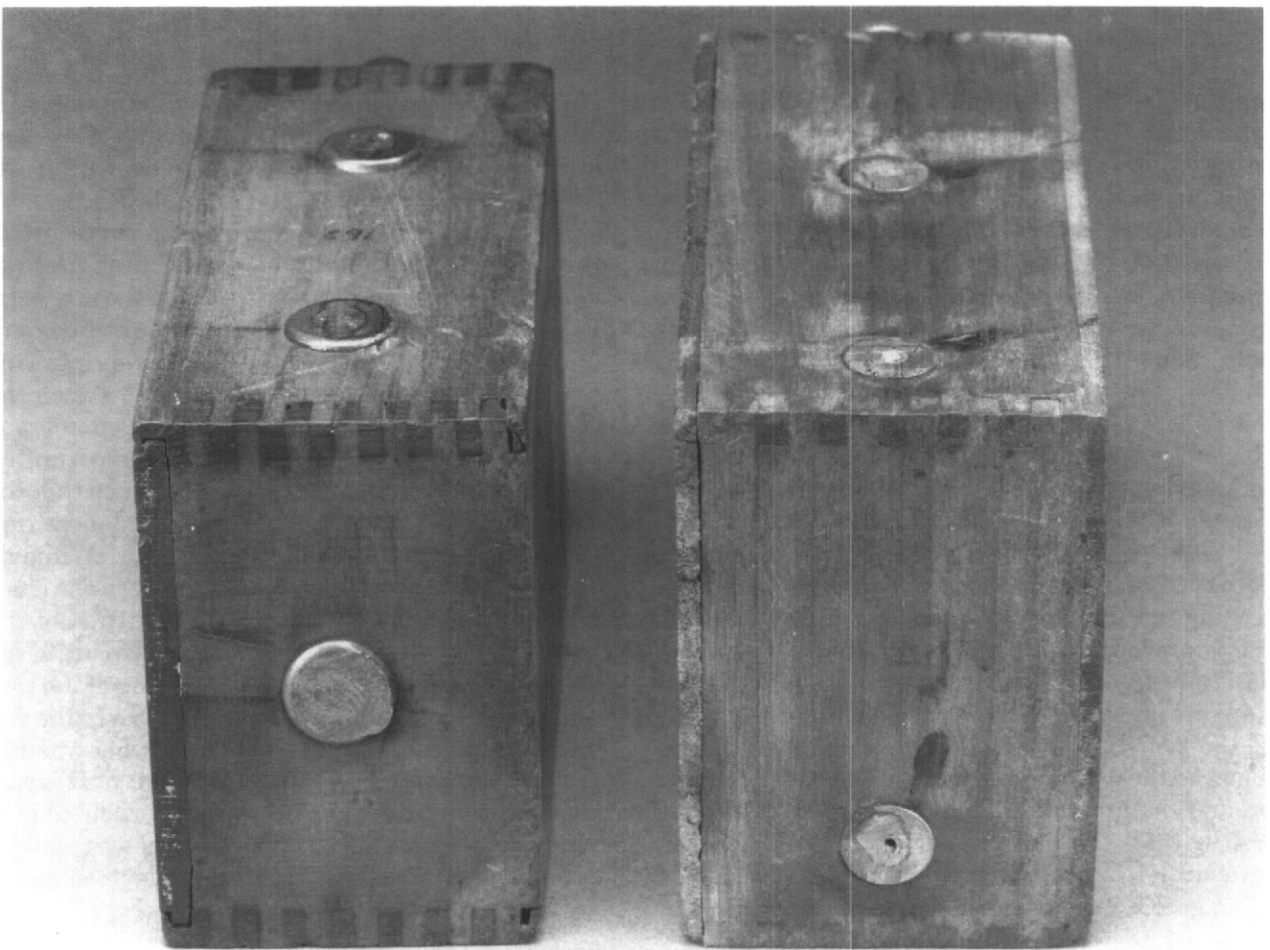
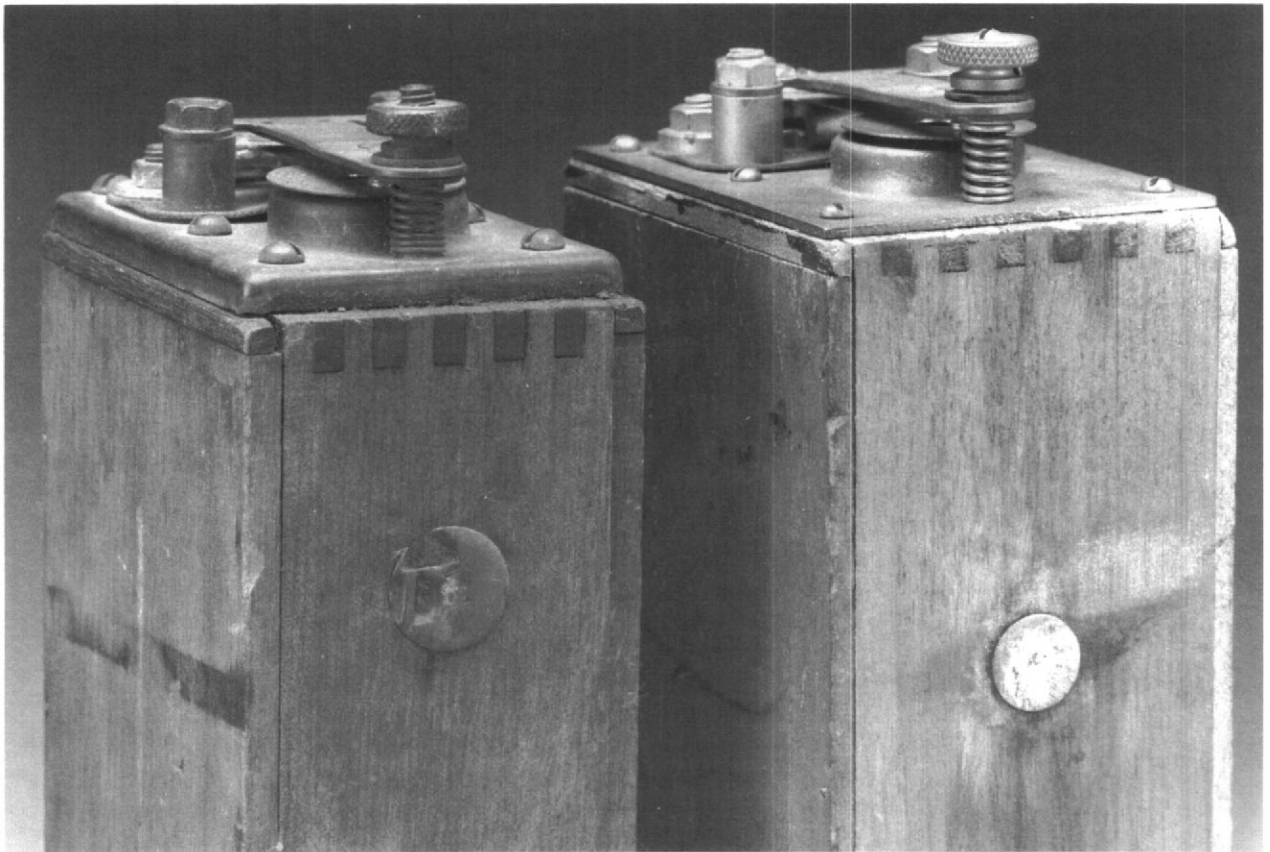

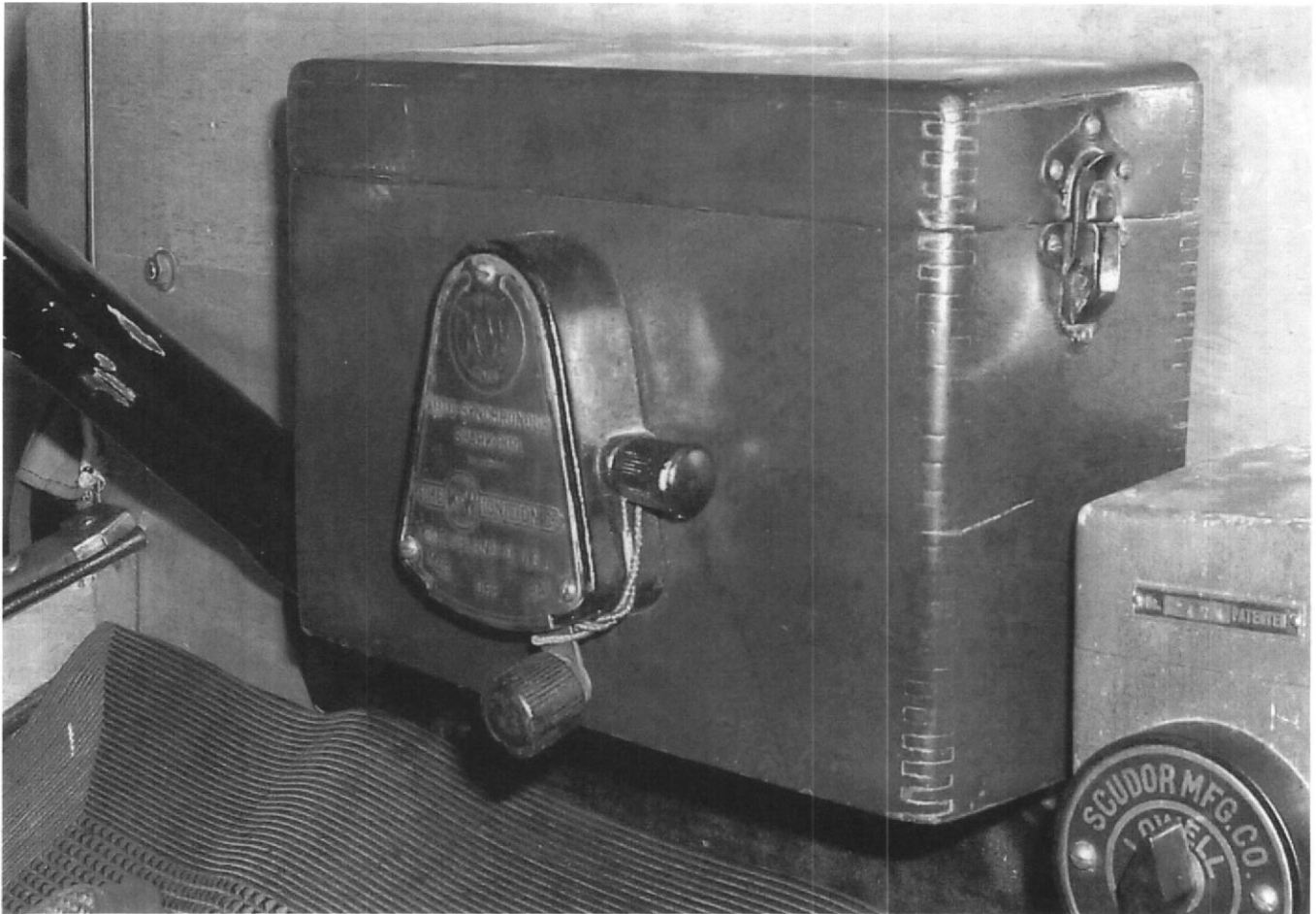

Photo 5: *The K-W coilassembly used in late 1912 and early 1913.*

ing the size that coil makers were to make their coils to and the location of the contacts on the outside of the coils. In February or March 1913, Williams met again with the Ford engineers. As a result of this meeting Williams redesigned the K-W coil so that its size would conform to the Ford specifications. He also made other improvements in the design that would enhance the coil's performance. After this redesign, K-W coils exhibit the stamped brass base that is characteristic of "brass top" coils. On March 5, 1913 Williams also took the step of applying for a US patent on the redesigned coil. US letters patent # 1,092,417 was awarded to Joseph A. Williams on April 7, 1914. (See Photo 6)

What made the K-W coil superior to Heinze, Jacobson and Brandow, and Kingston coils? According to Williams' patent, the principle basis for the improved performance of the K-W coil was the design of the primary circuit winding around the iron core and the design of the vibrating component of the points. Contemporary coil manufacturers followed the practice of winding the primary circuit around the iron core so that the core extended out well beyond the end of the windings. When the primary circuit was energized, the resulting lines of magnetic force began to curve sharply immedi-

ately after the end of the windings, thus making the intensity of the magnetic field at the end of the core much weaker than the magnetic field within the windings. (See Figures 2 & 3 in Photo 7).

Williams thought that the sharp curvature of these magnetic lines of force contributed towards two problems. First, the weak state of the magnetic field made it necessary for the manufacturers to use a very weak tension of the vibrator spring. This tended to make for a poor connection between the contact points just before the primary circuit was energized. Second, and perhaps more importantly, the curvature of the lines of force was such that the strength of the magnetic field increased more rapidly than the tension in the vibrator. Williams asserted that this caused the lag between the energizing of the primary circuit the induction of the high-tension spark in the secondary circuit to depend upon the distance between the top of the core and the bottom of the vibrator spring. Since the gap between the core and the vibrator spring was frequently different from one coil to the next, especially as owners attempted to adjust their coils to produce fatter and hotter sparks, this was a major reason why it was difficult to achieve complete synchronization of all four coils.

1,092,417.

Patented Apr. 7, 1914.
2 SHEETS—SHEET 1.

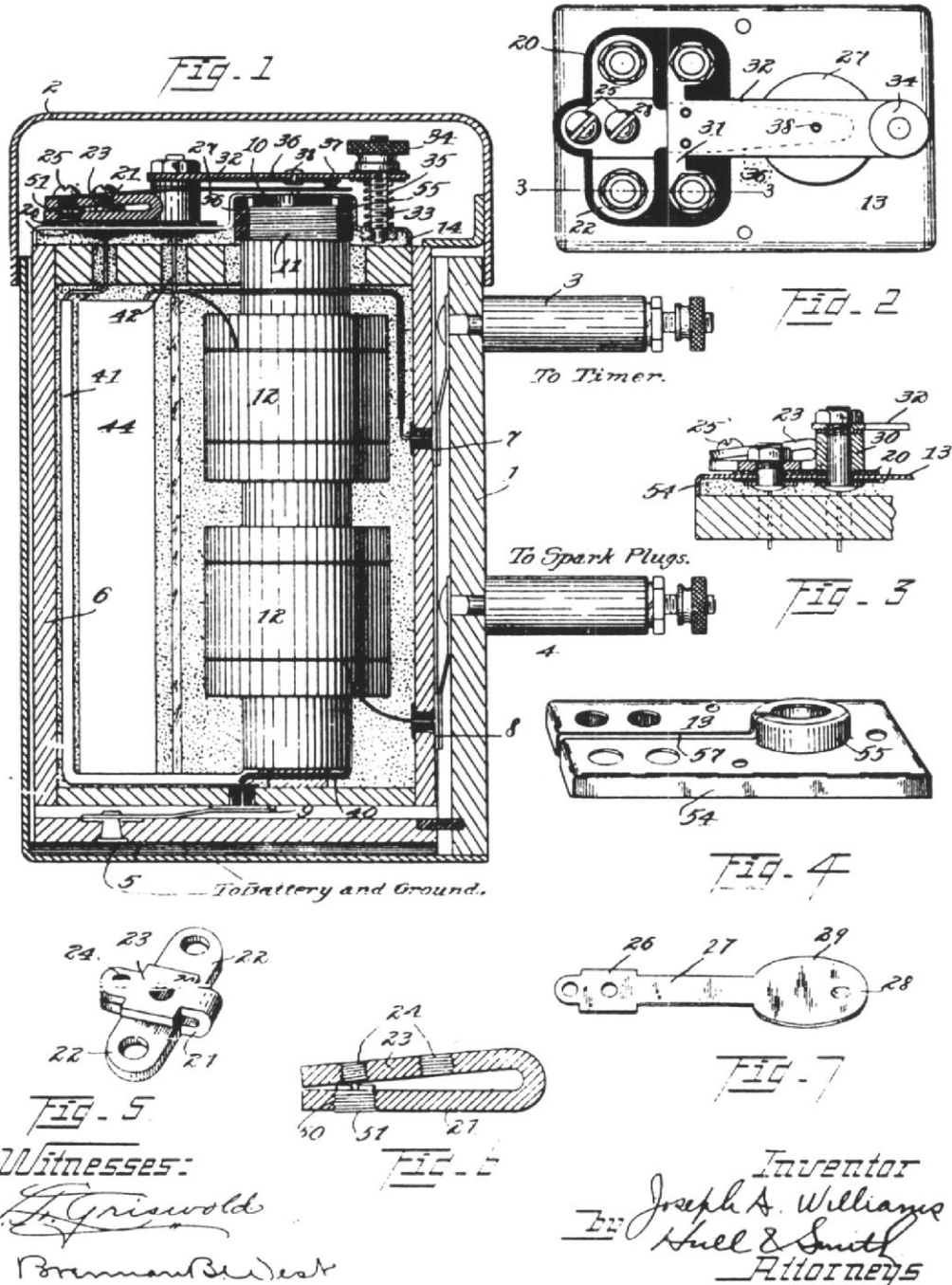

Witnesses:
H. Griswold
Borenman & West

Inventor
Joseph A. Williams
By *Hull & Smith*
Attorneys

Photo 6: Illustration from Joseph A. Williams 1914 patent for the K-W coil showing the various parts of the coil. Although Williams attached little significance to the cushion spring on the upper contact bridge, some Ford engineers thought that it was this feature that made the K-W coil superior to the other coils then on the market.

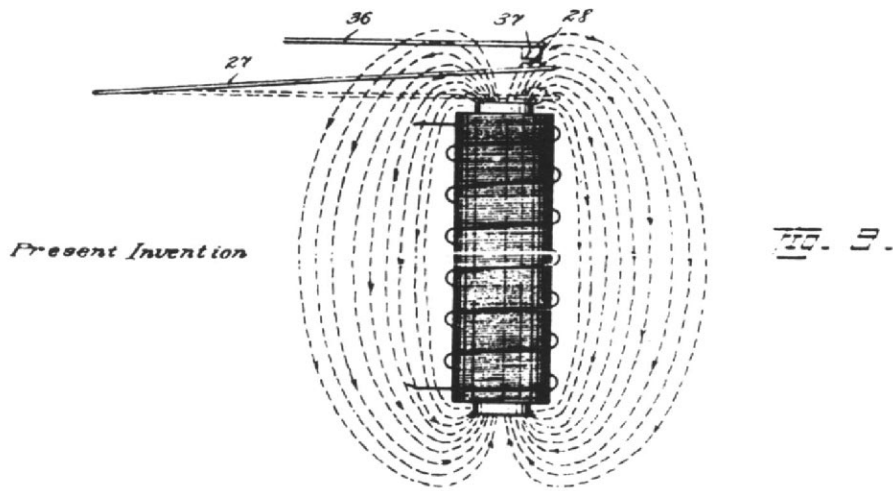
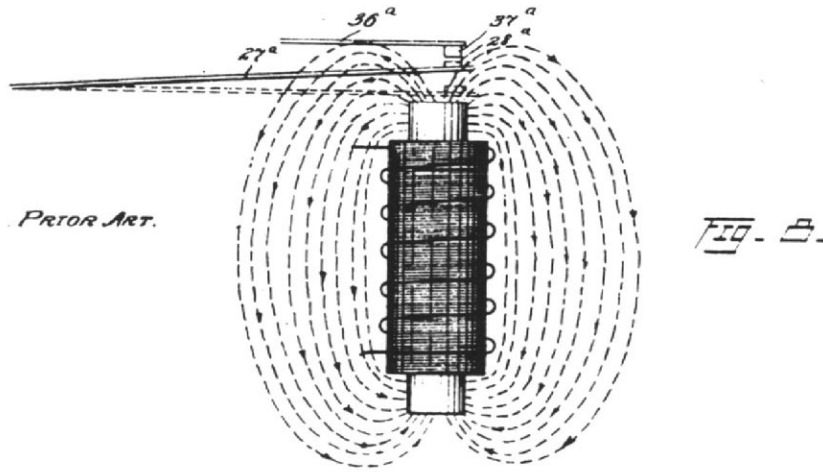

Witnesses.
R. L. Bruck
Bornman West

Inventor
Joseph A. Williams
Hull & Smith
Attorneys

Photo 7: Illustration from Joseph A. Williams 1914 patent for the K-W coil showing the effect of extending the primary circuit windings to the end of the iron core. The result, shown in figure 2, is a magnetic field that extends further out from the end of the core and whose lines of force are straighter than those produced in a coil where the primary windings do not extend to the end of the iron core.

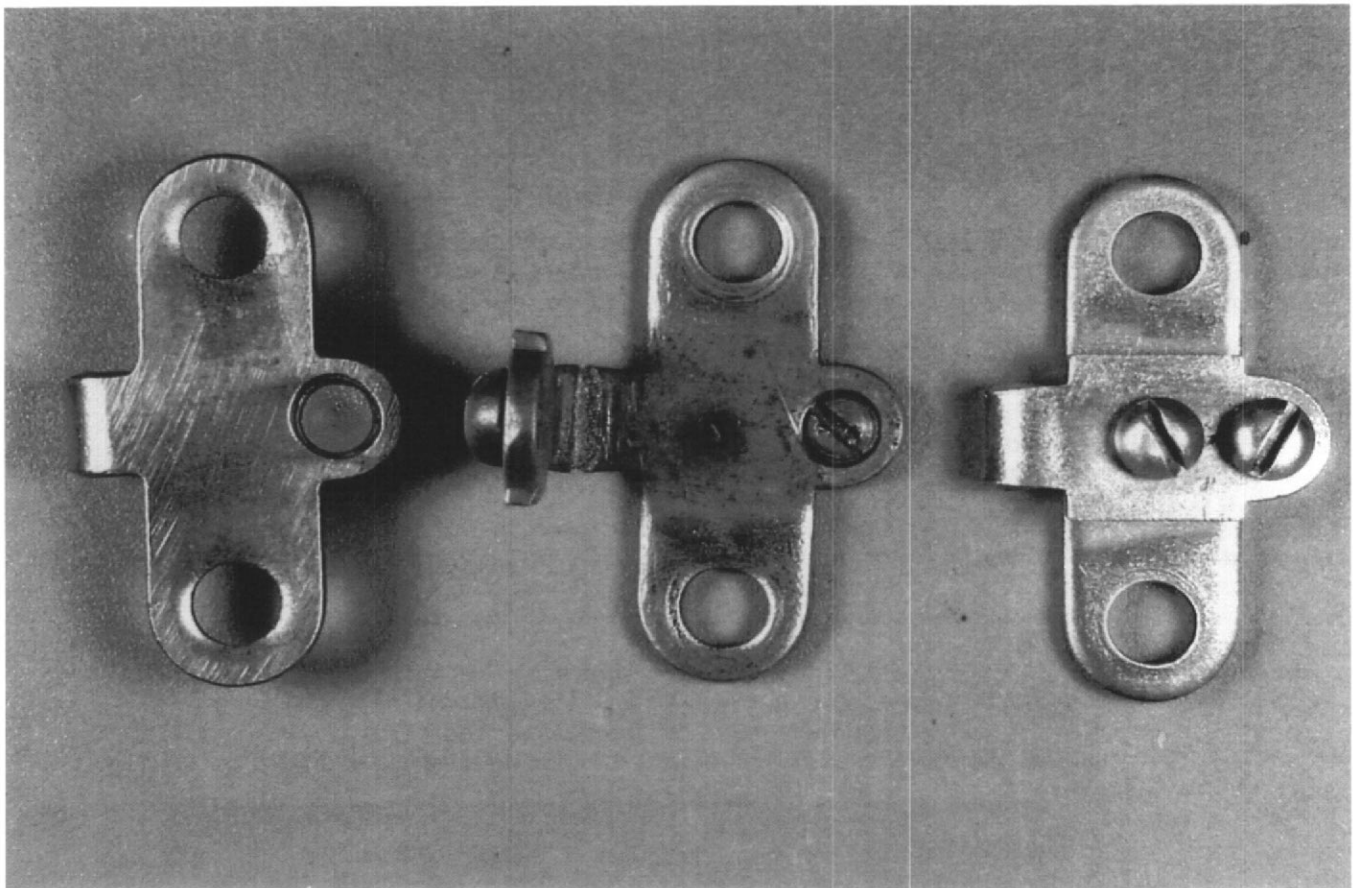

Photo 8: *The K-W coil assembly used in late 1912 and early 1913*

Williams claimed his coil design was different in that he extended the length of the windings of the primary circuit substantially to the end of the iron core. This tended to make the magnetic lines of force more parallel to the core and consequently the strength of the magnetic field increased more uniformly over the distance the vibrator traveled. Williams also changed the design of the vibrator itself so that the amount of tension to move the spring would be substantially the same over the entire range of movement of the vibrator. The tension of the vibrator to resist the magnetic pull of the core was adjustable through a “grub” screw that Williams had hidden in the vibrator spring’s base. This hidden location was chosen “so as to afford the least possible chance for ignorant, careless or unintentional displacement.” (See Photo 8)

Williams asserted that the significance of his design was this: as magnetic force from the core drew the vibrator downwards, the tension of the vibrator spring tended to increase at the same time the strength of the magnetic field increased. He claimed that this design was superior because the time lag of the spark and the strength of the spark’s intensity would not be affected by the wearing away of the surfaces of the contact points nor by the

vertical adjustment of the contact bridge. In Williams’ words “The consequence is that an engine operator can adjust the [contact bridge] screw...to his heart’s content without interfering with the regularity of sparking the various cylinders.

The Ford engineers rightly believed that there was an additional feature of the Williams coil design that was not mentioned in the patent but that nevertheless improved its performance. This feature was the cushion spring on which the upper point contact was mounted. Model T coils “buzz” because the coil is cycling and the points are vibrating at nearly 17,000 times per minute. This means that the time of contact between the points when current flows through the primary circuit and the magnetic field is building up is extremely short. The Kingston, Heinze and Jacobson and Brandow designed coils all had the upper contacts on their points fixed. The rapid movement of the vibrator frequently caused “rebounds of the vibrator,” or point bounce. Literally the two contact points would bounce off of one another before a good contact between the points could be made. These rebounds caused a damping effect on the build up of the magnetic field by the primary circuit and consequently had a tendency to reduce the voltage

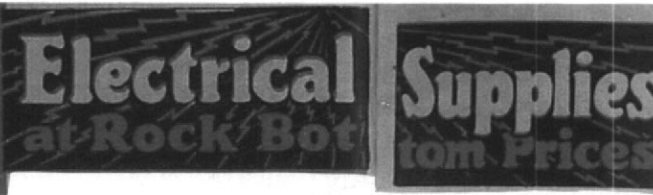

Photo 9 (Above): Advertisement for K-W points and coils from the catalog of a 1920's automotive parts retailer. K-W sold millions of points and replacement coils to Model T Ford and Fordson tractor owners through these channels.

Photo 10 (Below): These women employees at the Ford Motor Company were employed in the coil manufacturing department during the early to mid-1920's. They appear to be winding the primary circuits onto the iron cores of the coil.

From the Collections of the Henry Ford Museum & Greenfield Village. Neg. no. P.O.- 7330.



Photo 11: (Top Right Facing Page) Another view of the coil assembly line at Highland Park. In this operation the workers appear to be assembling the secondary windings of the coil to the primary windings and the iron core.

From the Collections of the Henry Ford Museum & Greenfield Village. Neg. no. P.O.- 9395.

Photo 12: (Bottom Right Facing Page) The photograph shows the final assembly of the coil units. Empty boxes can be seen on the left, and as they progress towards the right hand side of the picture, the various components of the coil are being added.

From the Collections of the Henry Ford Museum & Greenfield Village. Neg. no. P.O.- 6412.



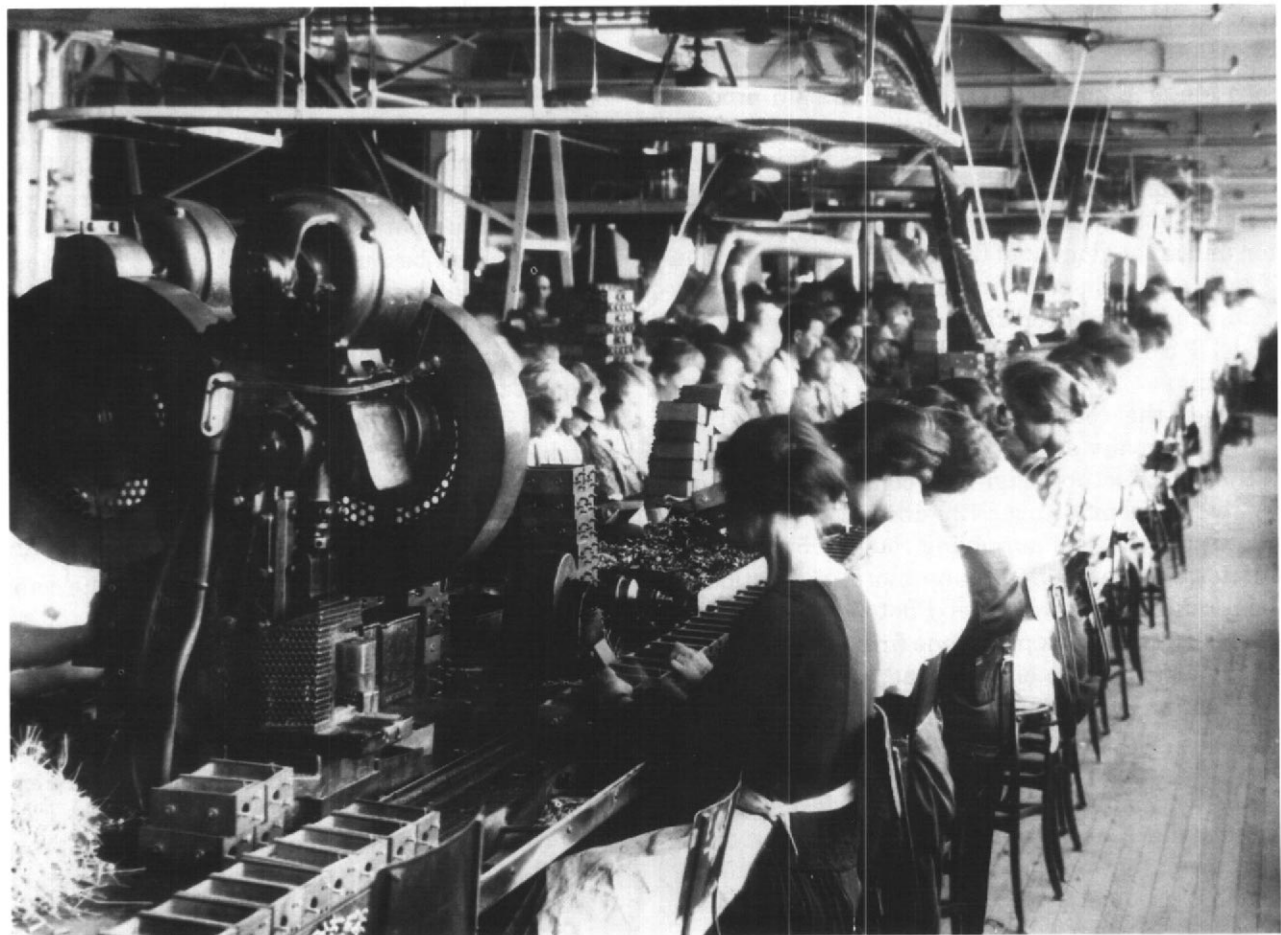
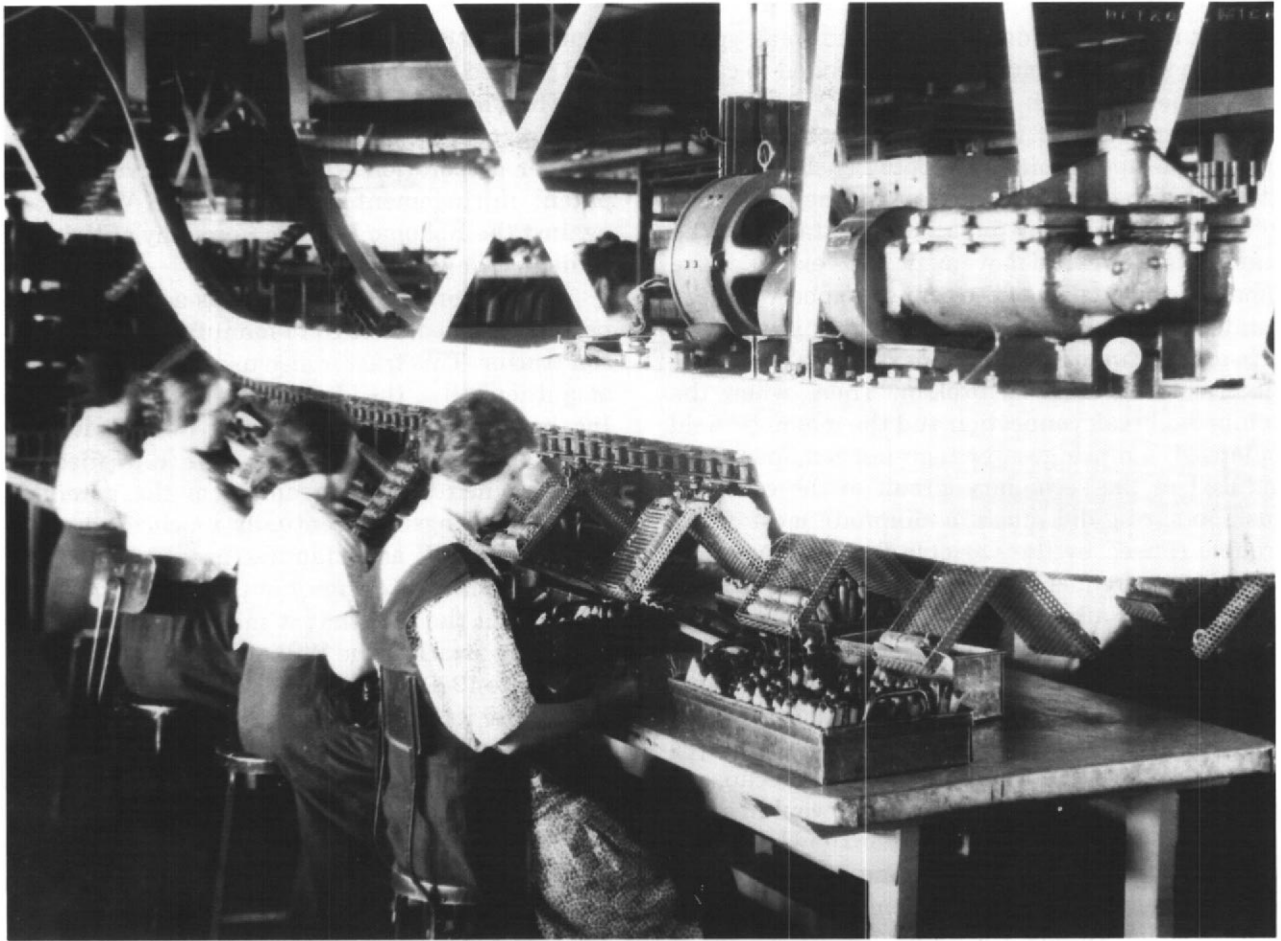

induced in the secondary circuit. The weak spark from the secondary circuit in turn tended to cause the engine to misfire.

Williams solved the rebound problem by attaching the upper point contact to a cushion spring. This design allowed the contact on the top bridge to follow the vibrator for a short distance at the start of its downward movement. This extended the time and the quality of the connection between the points and allowed the magnetic field in the iron core to build up to its maximum strength before the electrical contact was broken. Then, when the points did break connection and the magnetic field collapsed, a much greater high-tension spark was induced in the secondary circuit of the coil. The cushion spring did much to eliminate most of the trouble caused by the variable factors of voltage, current and frequency in the Model T magneto.

Sometime after May 1913, the exact date is not known, Ford decided to standardize on the Williams coil produced by the K-W Ignition Company. Thereafter, all Model Ts were equipped with Williams design coils. At the time of adoption it was understood between Ford and K-W that because of Ford's extensive business that there would be two sources of supply for these coils. Ford had long since established the practice of having two sources of supply for all of the major components of the Model T. This policy avoided the damage and delays that could result from strikes, fires and other disruptions of business that might result if only one supplier was used. During the first half of 1914 the Ford Motor Company took steps to begin production of coils following the Williams design in its own Highland Park factory. The newly established coil manufacturing department was equipped by Ford Motor Company, but Williams assisted in the selection and arrangement of the machinery. Production of coils by Ford seems to have begun during May 1914, and thereafter the enormous demand for Model T coils was supplied by both Ford and K-W Ignition.

Over the course of the next six years Ford Motor Company and K-W worked closely together in the manufacture of ignition coils. Between them the two firms made over 12 million coil units. K-W was responsible for supplying roughly 5 million of this total and supplied many more in addition to the retail trade as well. (See Photo 9) On occasions when shortages took place, one firm would lend the other parts so as to ensure that the production of coils was sufficient to meet the demand. However, Williams and K-W never bothered to inform the Ford Motor Company that it had applied for and received a patent on the Williams' designed coil. Neither did K-W ever mark any of their products with the patent number, or suggest in any commu-

nications with Ford that the coil, or any of its parts, was covered by a patent.

The Ford Motor Company did not learn of the Williams patent until several years later when another corporation was indirectly involved in a patent infringement suit filed by K-W Ignition against the Kokomo Electric Company of Kokomo, Indiana (Kingston).

Henry Ford and Son, Inc, was a Michigan corporation formed in 1916 to manufacture the Fordson tractor. This tractor also used the same design of ignition coil as the Model T. Henry Ford and Son, Inc. had placed an order with the Kokomo Electric Company (Kingston) for some coils. K-W filed suit and enjoined the infringement of the patent by Kingston. Kingston eventually reached an agreement with K-W and manufactured many coils to the Williams/Ford design, but the importance of the suit lies in the fact that it made the Ford Motor Company aware of the Williams patent.

In late 1919 the K-W Ignition Company decided to exercise its right over the Williams patent with Ford. They filed suit in the US District Court in Indiana against Ford for infringement of the Williams patent, seeking to stop Ford's production of coils and seeking damages for past infringements. This court ruled in favor of K-W Ignition, and the Ford Motor Company appealed to the US Circuit Court of Appeals for the Seventh District in 1920.

Ford Motor mounted a vigorous appeal based on invalidity of the patent, laches (an inexcusable delay in enforcing K-W's patent claim), non-infringement of the patent within the State of Indiana where the suit was filed, and estoppel. The Court of Appeals based its decision in favor of Ford on this last argument. Estoppel is a legal principle that prevents a person from making an assertion of a patent claim because it is contrary to a previous assertion that he has made. In the case of Ford Motor Company vs. K-W Ignition Company the court found that Williams and K-W had made no attempt to notify Ford Motor of its patent, but had instead induced Ford to adopt the Williams design coil, had assisted in the establishment of Ford's coil manufacturing department, and had sold Ford Motor an extensive proportion of the parts and material necessary to manufacture coils. Given K-W's failure to assert its patent claims earlier, the court ruled it had no right to assert them later.⁵

During the 1920s Ford's production, and consequently the demand for ignition coils, continued to grow. In 1923 over eight million coils were needed just to meet the requirements of new Model T production. Many more were sold through dealers and agents to owners of earlier Model Ts. The Ford Motor Company continued to expand and improve its coil-manufacturing department. One of the in-

interesting features of this department was that it was one of only three or four departments at Highland Park where women were employed in regular production work. During 1925, 394 women were regularly employed in this department.⁶ Period photographs of the coil department at Highland Park show women winding the primary and secondary circuits around the iron cores and assembling the components into the wooden boxes. (See Photos 10, 11 and 12) Ford appears to have been an early leader in equal pay for equal work. Women received the same minimum dollar per hour wage that males received.⁷

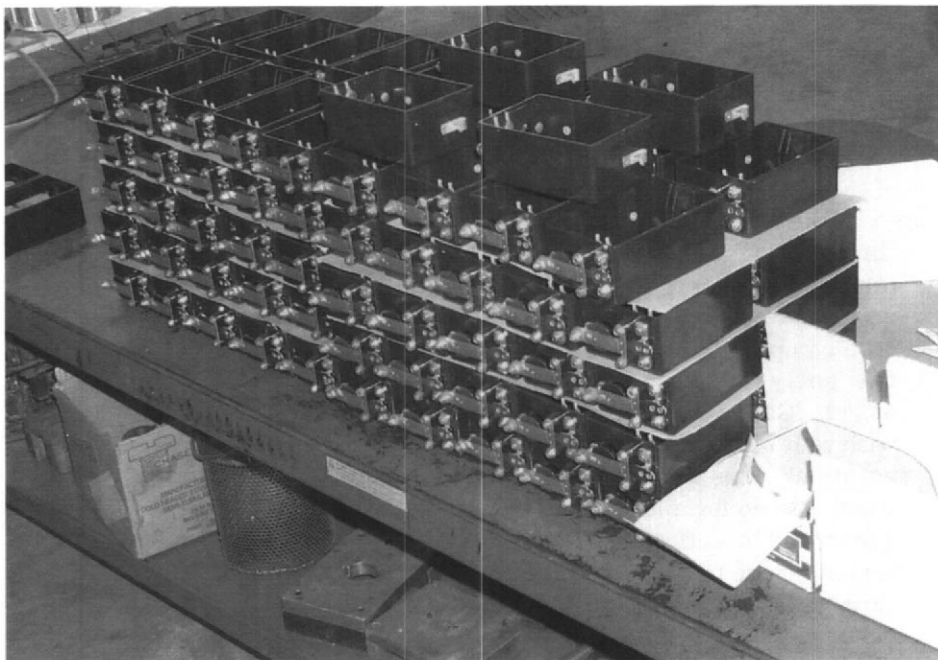

Photo 13 (Above): *The new K-W coil final assembly line at Bob's Model T Parts.*

The end of Model T production in 1927 marks the beginning of the end for the K-W Ignition Company. Apparently K-W did not engage in research and development of new products, and the end of the Model T left it with no new product to take the

place of the vibrator ignition coil. K-W continued to supply new coils and replacement points to the retail trade, but this market continued to dwindle as the number of Model Ts used daily diminished during the 1930's. K-W did develop an alternative use for the vibrator ignition coil as a device to electrically charge farm fences, but again this market was small and extremely limited compared to the former demand for Model T coils. In 1940 the K-W Ignition Company went out of business. K-W's plant and equipment were purchased by the firm of Jack and Heintz, Inc. soon thereafter.⁸ Eventually Blackstone, a Chicago based company, took over the manufacture and sale of repair parts. Blackstone continued to supply K-W marked coils and points to the retail market until the end of 1998.

In January 1999 Blackstone sold the designs and tooling for K-W coils and the rights to the K-W trademark to Bob's Model T Parts of Rockford, IL. The machinery has been moved and installed at Bob's Rockford facility and the production of K-W coils and points has resumed. (See Photo 13) □

Footnotes

¹Accounts Receivable for K-W Ignition, 1911-1916, Accounting Records: Ford Motor Company 1904-1914, Accession 623, Research Center, Henry Ford Museum and Greenfield Village. Hereafter cited as Research Center.

²Ford Motor Company vs. K-W Ignition, No. 2879, US Circuit Court of Appeals for the Seventh Circuit, April Session, 1921. A Ford factory letter dated November 6, 1912 also states that about 10% of the 1913 cars are to use K-W coils. Accession 509, Factory Letters, Research Center.

³US Letters Patent #1,092,417, pp. 3-4.

⁴Reminiscences of H.L. Maher, Accession 65, Box 43, Folder #1, Research Center, pp. 17-18.

⁵Ford Motor Company vs. K-W Ignition Company, 7~ US District Court of Appeals, No. 2879, October Term, 1920, April Session, 1921.

⁶Daily Factory Count for January 6, 1925: Department 5845 Coil Unit, Accession 732, Research Center.

⁷Letter from E.G. Liebold to C1~istabel Pankhurst dated October 29, 1921, Accession 285, box 37, folder "C", Research Center.

⁸1941 Cleveland Buyers Guide, The Cleveland Chamber of Commerce, Cleveland, Ohio, 1941.

The authors may be contacted by writing:

Trent E. Boggess
Department of Business
Plymouth State College
Plymouth, NH 03264
e-mail: Trentb@oz.plymouth.edu

Ronald Patterson
8 Olde Surrey Lane
Medway, MA 02053
e-mail: Modeltcoils@sprynet.com

The Model T Ignition Coil

Part 3: Chronology of the Ford/K-W Coil Unit

By Trent E. Boggess and Ronald Patterson

“Specified the name FORD to be burned in script on the side of box.”
Joseph Galamb, “Record of Changes for T-5845 Coil Unit Assembly,” March 19, 1919

Knowledgeable Model T owners are aware that many different variations of the Ford/K-W ignition coils exists. Indeed, there may be no other Model T part for which so many different examples can be found. So many changes were made to these coil units that it is difficult to list them all, let alone find examples of each. Fortunately, it is now possible to roughly date particular Model T coils. Once the production of coils began in-house, Ford, following its standard practice for other Model T parts, began keeping detailed records regarding the design and components of the coil unit assembly. This information has survived to the present day in the form of “Record of Changes Cards,” often times referred to as “Releases,” in the collections of the Research Center at the Henry Ford Museum and Greenfield Village. These documents have allowed us to construct a chronicle of the variations of Model T coils as they were built by the Ford Motor Company.

Before embarking on the design history of the Ford/K-W Model T coil, a word of caution is in order. The ignition coils that were supplied as regular equipment for Model T Fords after 1914 and Fordson tractors were manufactured by three different companies: K-W Ignition, Kokomo Electric and Ford Motor. This chronicle describes the coils as they were built by Ford. There is evidence that K-W Ignition Company did not always change the design of its coils so as to exactly duplicate those made in the Ford factories. Indeed, coils exist with features that the “Releases” would indicate were never made by Ford. An educated guess is that the “Releases” identify the features of Ford-built coils, and that coils that differ from these designs were built by K-W who probably followed in (or may have led) Ford practice. What follows is our best attempt to categorize and illustrate the features of different Model T ignition coils and to approximately date their use on the Model T Ford.

1913 K-W Ignition Company Coil

The logical starting point for the chronicle of the Ford/K-W coil unit is the K-W Ignition Company’s coil of early 1913. This unit resembles the later brass top units with some significant differ-

ences. First the outside dimensions of the coil unit are somewhat larger than the later standardized coils. Second the placement of the contacts is different. The two front side contacts are lower than on the later coils and the bottom contact is located to the rear of the coil rather than the center. (See Photo 1.) Finally, the metal top is also distinguishably different. The metal top is made of a flat sheet

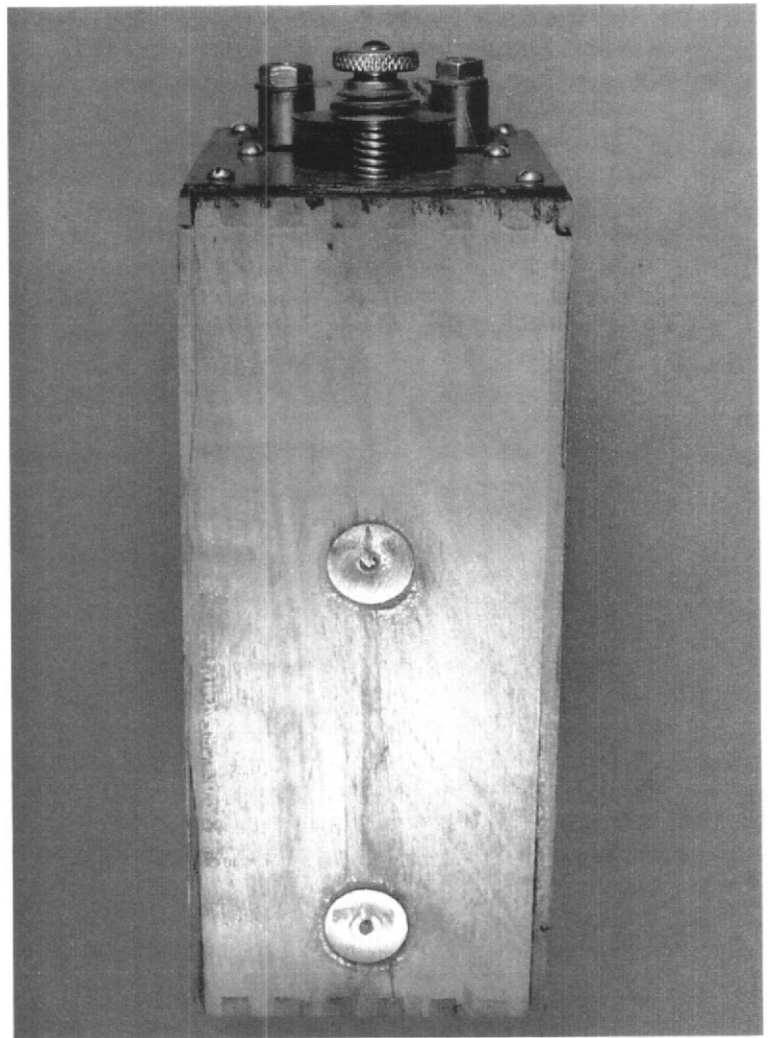

Photo 1: A K-W coil used in late 1912 and early 1913. The wood box is thicker and the contacts are in different locations as compared to its later counterparts. Note the knurled brass thumbnut that adjusts the gap between the points.

of brass held to the top of the wood box by six brass round head screws. On examples in good condition, the metal tops appear to have a black anodized finish, rather than natural brass color. The coils use the standard design K-W points that can be readily replaced with new production points. (See Photo 2.)

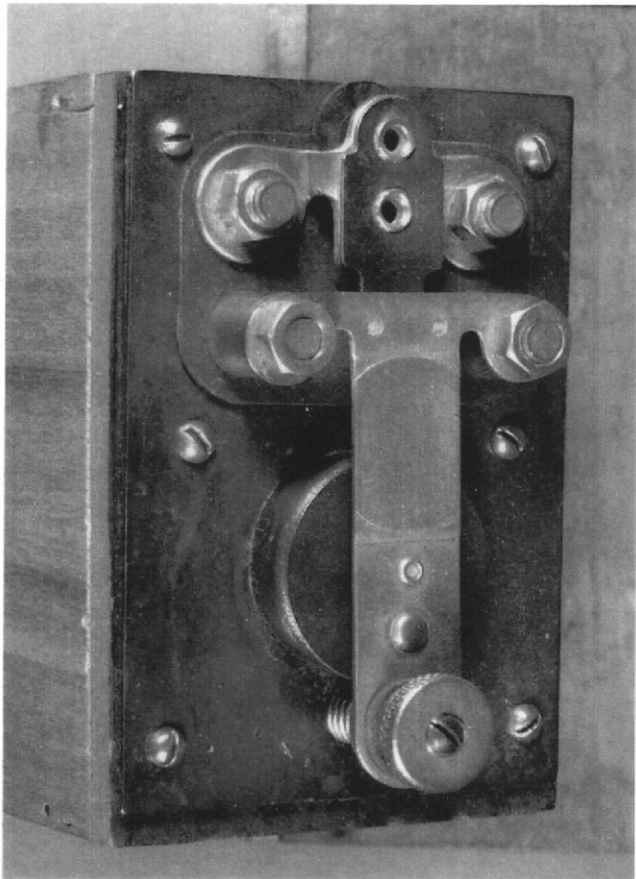

Photo 2: Close-up view of the top of the late 1912/early 1913 K-W coil. Note the flat brass top on this coil with a dull black finish. The thumbnut that adjusts the gap between the points is made of brass and does not use a lock nut to keep the gap setting fixed. Instead, the mounting stud is split and spread to provide resistance to keep the adjusting nut from turning on its own.

The 1913-15 K-W and Ford Brass Top Coil

The redesign of the K-W coil unit in conjunction with the Ford engineers during April and May of 1913 resulted in the standard design brass top coil. Initially, these coils were supplied solely by K-W Ignition, although Heinze made some coil units that conformed to the standard size and contact placement pattern and were interchangeable with the K-W coils in the later metal coil boxes. (See Photos 3 and 4.) Sometime

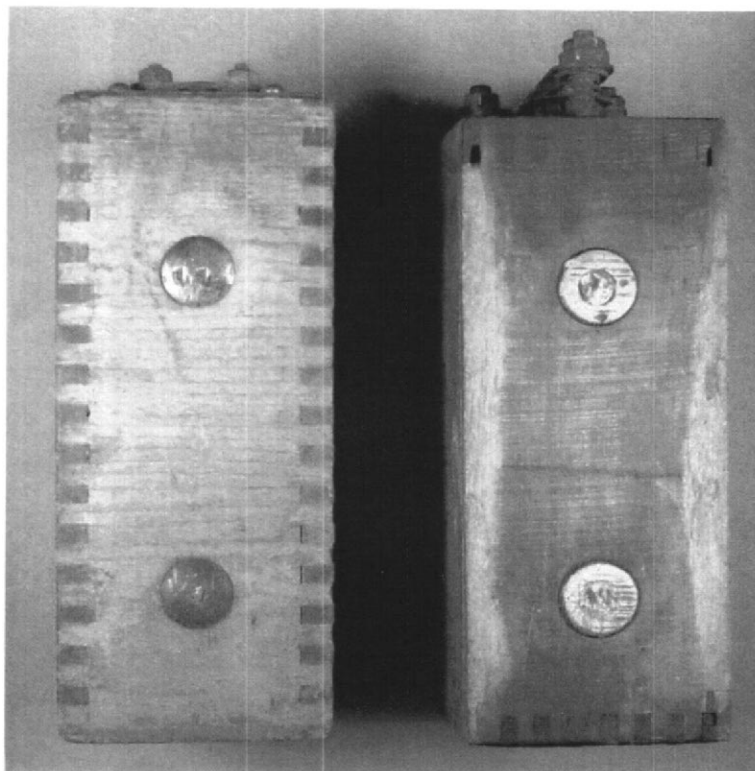
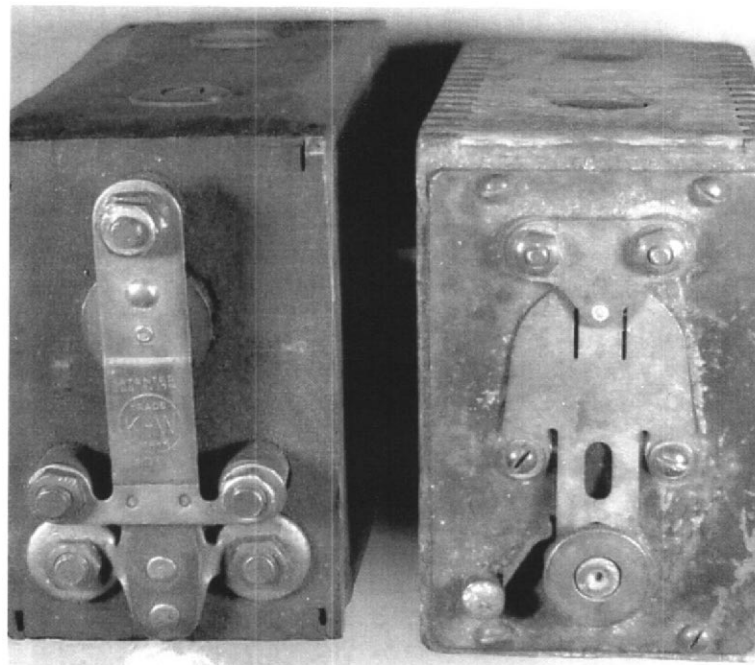

Photo 3 (Above): A 1913-14 Heinze coil (left) compared to a standard Ford/K-W coil. These Heinze coils were manufactured to the standard size as the Ford/K-W design and the placement of the contacts on the side and top are identical with the Ford/K-W design. These Heinze coils will fit perfectly in a standard Model T metal coil box.

Photo 4 (Below): Top view of a 1913-14 Heinze coil (right) compared to a standard Ford/K-W coil. While the size and contact location of the Heinze coil was the same as on the Ford/K-W coils, these coils used the standard late Heinze coil points.



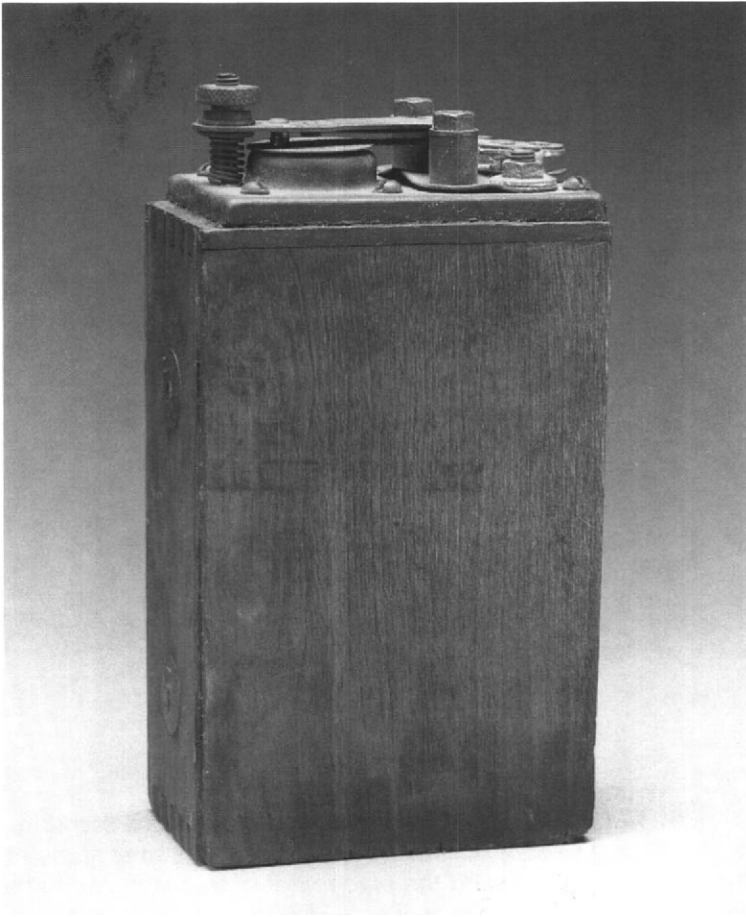

Photo 5: *Left-hand side of a late 1913 to late 1915 Ford or K-W coil. This side of these coils is held to the four adjacent sides by glue.*

around the month of May 1914 the Ford Motor Company set up its own coil manufacturing department at the Highland Park factory. The coils that Ford produced there appear to match those produced by K-W at that time.

The coils produced from mid-1913 until about November 1915 differ from later brass top coils in several key respects. The construction of the wood coil unit box was such that the two largest sides were made simply as flat pieces of wood, and glued or nailed to the other four sides of the box. The left side (from the driver's position) was glued to the top, bottom, front and rear sides while the right side was nailed to the other four pieces with brads. Ford specifications called for the use of ten brads to hold this side to the rest of the box. (See Photos 5 and 6.)

The Ford engineering documents refer to the brass top on these coils as the "Vibrator Base." Initially it was made from sheet brass. Beginning in October of 1914 the brass tops were dipped in lacquer, supposedly to prevent, or at least to slow the tarnishing of the surface of the brass. Most original brass top coils found today have tops that

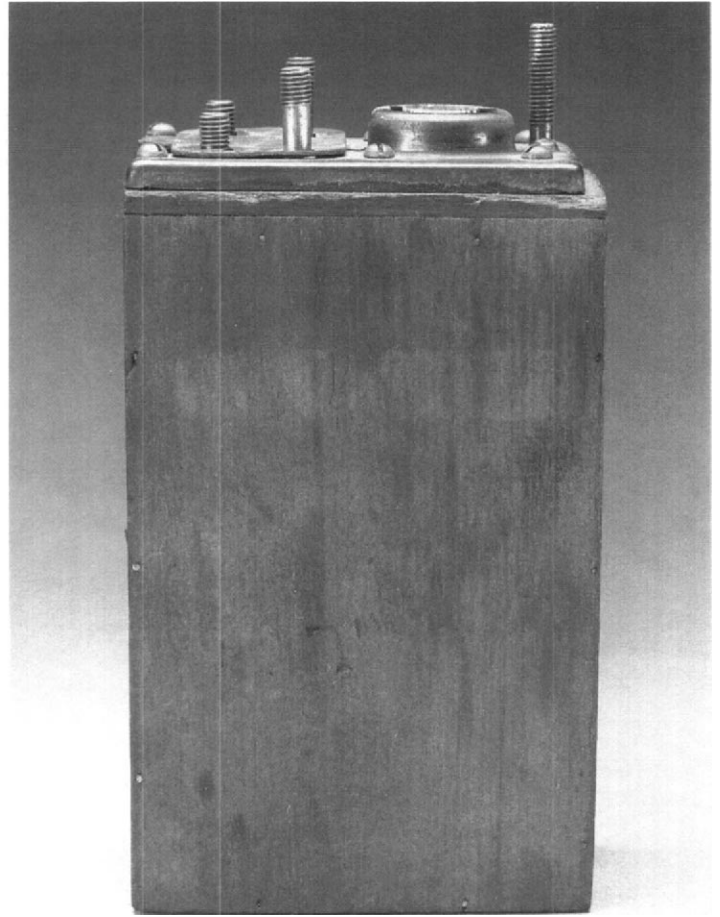

Photo 6: *Right-hand side of a late 1913 to late 1915 Ford or K-W coil. This is referred to as a "10 brad coil" because of the ten brads that hold this side to the four adjacent sides of the coil.*

are so severely tarnished that they appear almost black in color. But under protected surfaces, such as the insulator under the vibrator spring mount or on the underside of the base itself when it is removed from the coil, the natural brass can be seen. (See Photo 7)

Some brass tops appear to have a black anodized finish like the 1913 K-W coils units. (See Photo 8) There is no reference to this anodizing process in the Ford engineering documents. Since coils with this type of top frequently have features that were not used by Ford, it appears that these coils may have been made by K-W Ignition. The brass tops on both the Ford and the K-W coils produced during this era were held onto the wood boxes by six brass (or brass plated) round head wood screws.

The hardware that attached the points to the coil was made completely of brass. This includes all the nuts, the spools or collars that supported the upper point bridge at its two rear mounting points, and even the spring under the bridge adjustment nut. The bridge adjustment nut was also initially a

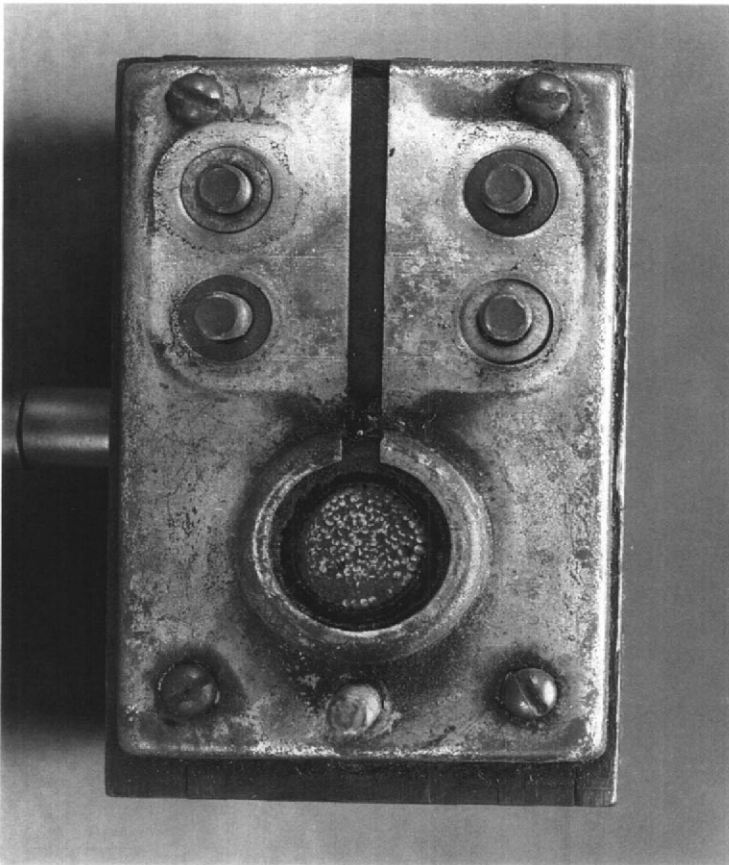

Photo 7: Overhead view of a brass top coil with the coil point mounting hardware insulator removed to show the bright brass finish underneath. Most, but not all, brass top coils are so tarnished as to appear almost black in color.

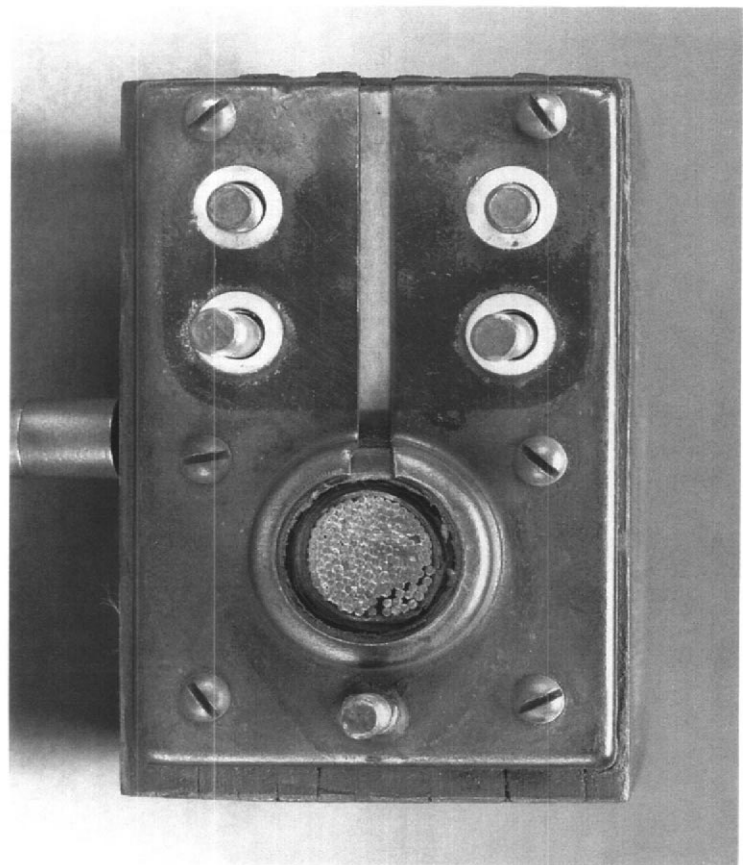

Photo 8: Overhead view of what is believed to be a coil made by K-W Ignition between 1916 and 1918. The brass tops on these coils have a black anodized finish that is clearly visible even when the coil point mounting insulator is removed.

brass thumb nut (See Photos 1 and 2 for views of a brass thumbnut), identical with the brass thumb nuts that held the commutator, high tension spark plug, and magneto wires to the coil boxes. The first bridge support collars, or spools, were simply brass

cylinders. Beginning in June of 1914 Ford began making them as spools where the top and bottom were 1/16" larger in diameter than the middle section of the spool.' (See third spool from left in Photo 9.)

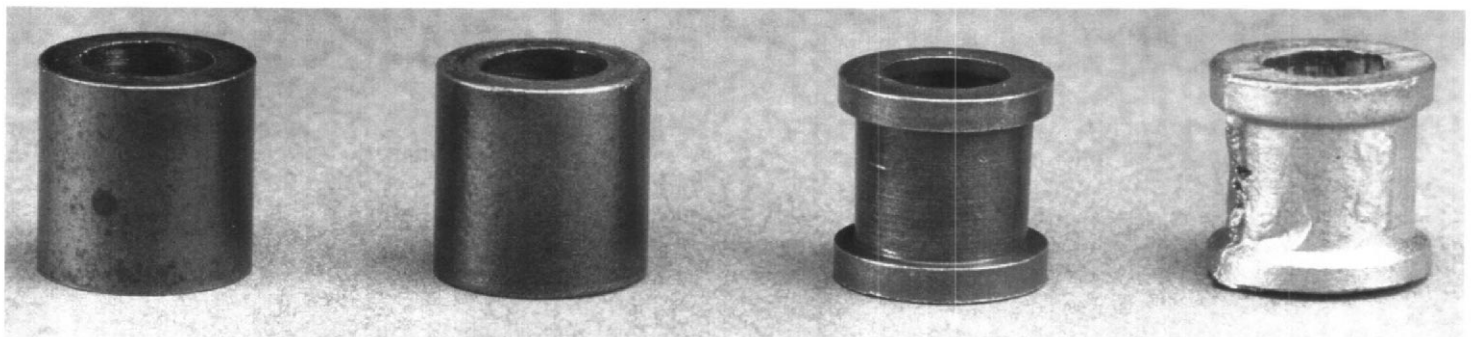

Photo 9: Photograph showing some of the different point bridge support collars or spools that were used on the Ford/K-W coils. The left spool is a simple brass cylinder. In 1914 Ford began turning the center sections of the collars it was making 1/16" smaller in diameter, making them true spools (note the third collar to the right). The second spool to the right is made of steel and was used from about mid 1917 to 1925 on Ford produced coils. The K-W Ignition Company may have continued to use the simple brass cylinders well after Ford changed to copper plated steel. The far right spool is made of die cast aluminum and was used from late 1925 through 1927.

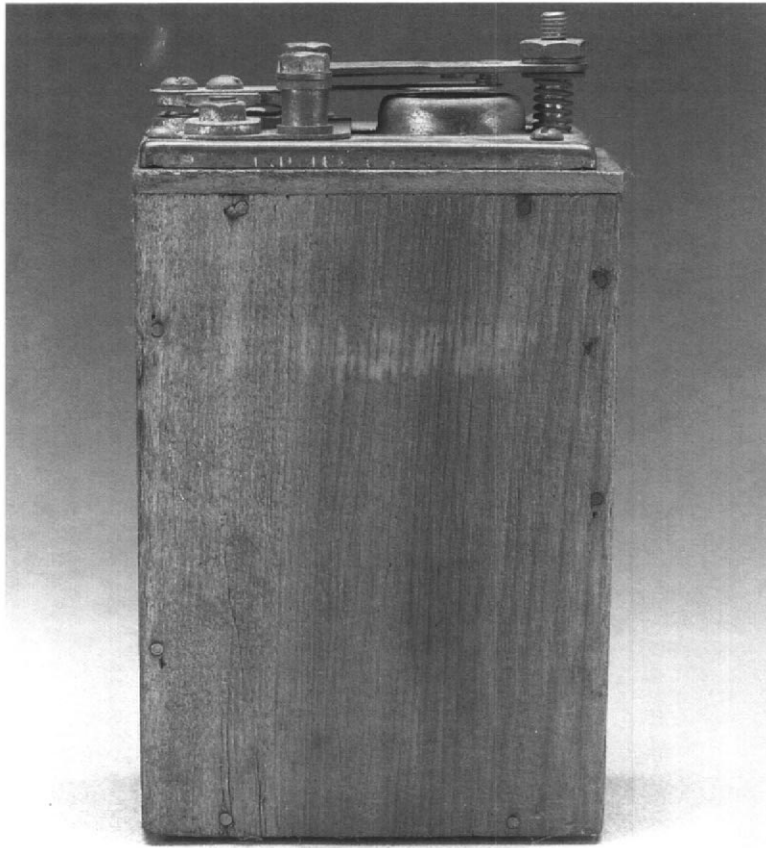

Photo 10: *View of the right-hand side of a coil made sometime between March 1915 and November 1915. This is referred to as the "8 brad coil" because the removable door side of the coil is held on with eight, really nine in this case-brads.*

Ford began making minor changes to the exterior design of its coils in March and May of 1915. These changes reduced the amount of material used in assembly of a coil and reduced costs. First, on March 20, 1915, the Ford engineers reduced the number of brads holding the removable door to the box from ten to eight. Now, two brads were used along each side of the door, instead of three along each of the two long sides. (See Photo 10.) In May, the two center screw holes in the brass top were eliminated and the number of brass round head screws used was reduced from six to four. (See Photo 11.) The internal parts of each coil were sealed against moisture by a black insulating, tar-like compound. Ford factory documents refer to this substance as "Ford Hydrolene." On April 26, 1915 the specifications for this compound were changed to require a minimum melting temperature of two-hundred degrees Fahrenheit.

The 1916-1917 Brass Top Coils

Ford made a major change in the design of the wood box used on the individual coils units in

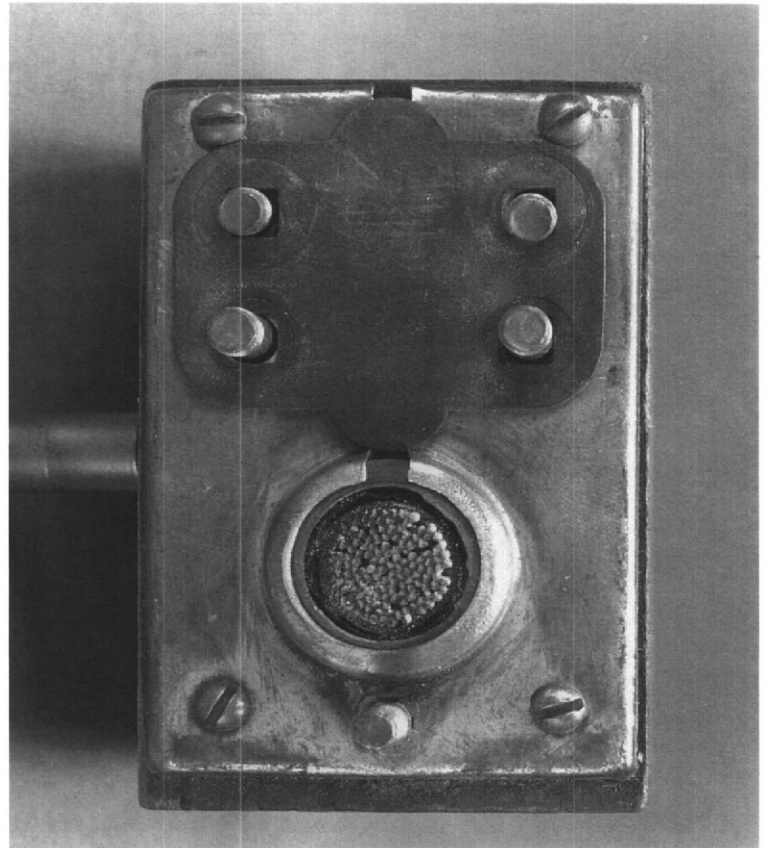

Photo 11: *Overhead view of a four-screw coil. Ford eliminated the two center screws in the tops of its brass top coils beginning in May of 1915. Evidence suggests that K-W continued to use six screws to attach the tops of its brass top coils after Ford changed to four.*

November of 1915. The wood box was redesigned so that the two large sides would be held in place by tongues and grooves. The removable door would also be held in place with tongues and grooves at the top and sides, but the bottom edge was now secured with just two brads. This tongue and groove design for the wood box would set the pattern for the balance of Model T production.³ (See Photos 12 and 13.)

While the Ford and K-W coil units produced during this time period were interchangeable, they were not identical. Brass top coil units can be found which use the tongue and groove box, but which also use six brass round head screws to hold the brass top to the wood box. It is believed that these coils were made by K-W Ignition. However, it is not clear if K-W adopted the new design of wood box before the change from six screws to four, or if K-W continued to use six screws after Ford changed from six to four and both firms had changed to the tongue and groove box.

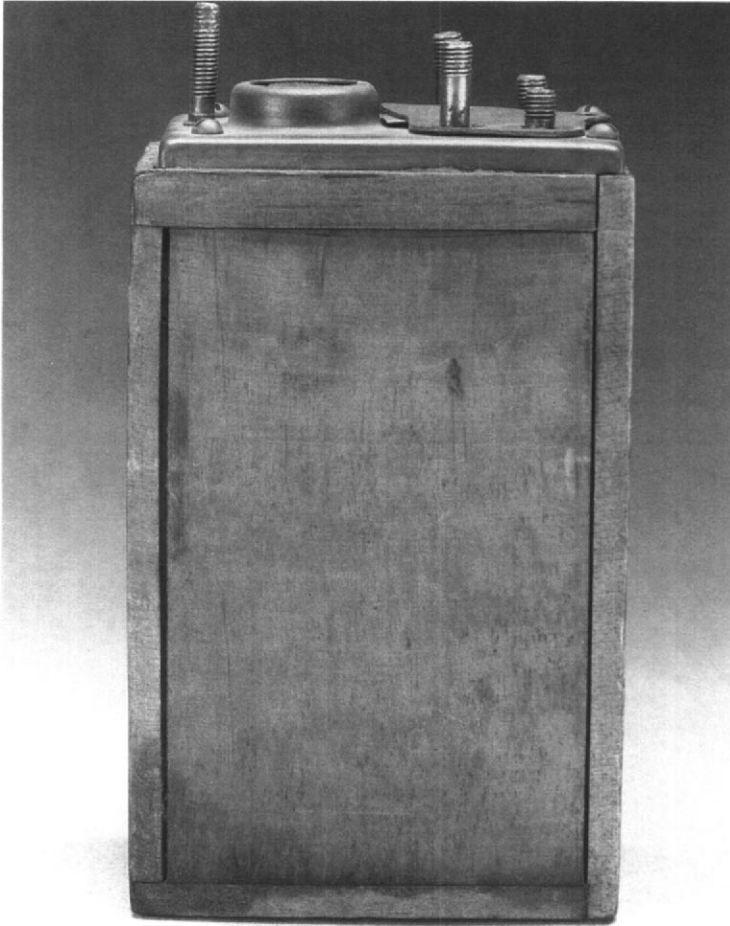

Photo 12: *The typical Ford brass top coil of 1916-1917. These coils have brass tops held on with four screws but the wood box is of the tongue and groove design.*

The 1917-1919 Wood Top Coils

With the entry of the United States into World War I and the demands that the war effort placed on certain strategic raw materials, including brass, Ford Motor Company had to change its manufacturing designs to conserve on these materials. This caused a major redesign of the coil unit in June of 1917. The brass top was removed and the coil points were now mounted directly on the wood top. (See Photos 14 and 15.) With the brass top removed, Ford engineers specified that the wood top was to be painted with a black, insulating paint. Steel hex nuts were substituted for brass, and the brass thumb nut was replaced by a stamped steel nut, 7/16" across the flats. The two collars that support the upper point bridge were changed from brass spools to copper-plated steel cylinders. These coils, like their earlier counterparts, are unmarked as to their manufacturer.⁴

At about the same time that the coils changed from brass tops to wood tops, the lower vibrator base was changed as well. Originally these bases had been made from brass, but on May 8, 1917 the

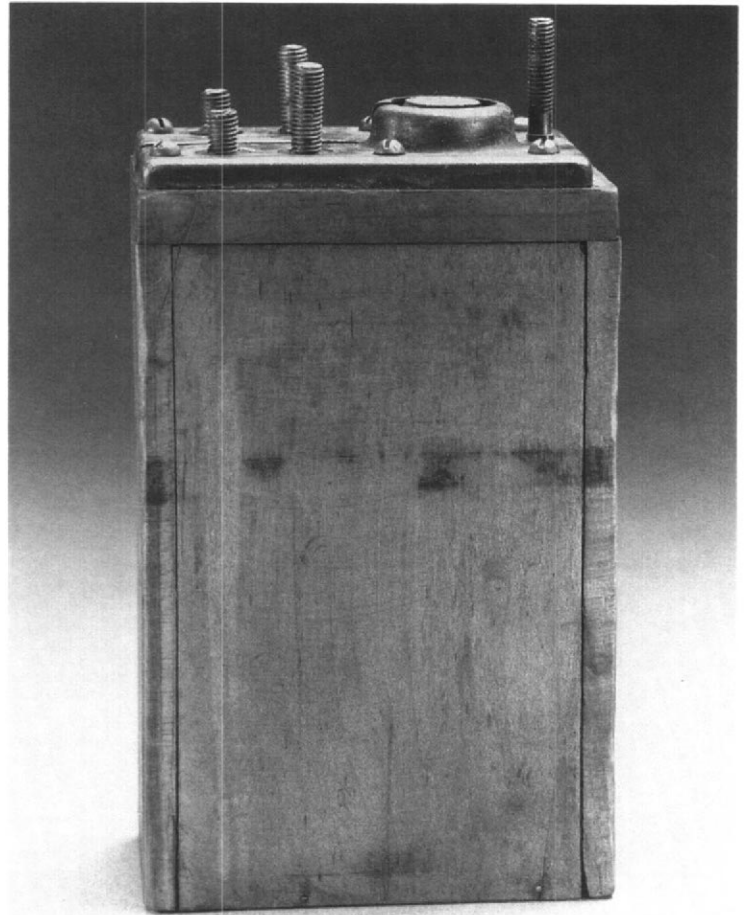

Photo 13: *This coil differs from the one shown in Photo 12 in that its brass top has a black anodized finish and it is held on with six screws. It is believed that this style of coil was manufactured by K-W because there is no reference to the use of an anodized finish and the tongue and groove box came into use at Ford after the change from six to four screws holding the brass top to the coil.*

base was changed from brass to steel. Then, a month later, a second change was made. The pad on which the vibrator contact spring was mounted was changed in shape from rectangular to an arrowhead shape. This change was made by the Ford engineers to accommodate the new design of the spring steel vibrator and for convenience in manufacturing. (See Photo 16.)

The 1916-1918 Fiber Case Coils

During July of 1916 the Ford Motor Company began production of one of the most unique designs of ignition coils used on the Model T. These coils are distinguishable by their box, which is made from a fiber composition. (See Photo 17 and 18.) Ford Motor Company records refer to this coil as the "Die Cast" design. Purportedly, the case was made of wheat gluten with an asbestos binder. The fiber case coil is completely interchangeable with the standard wood-boxed K-W/Ford design. It appears

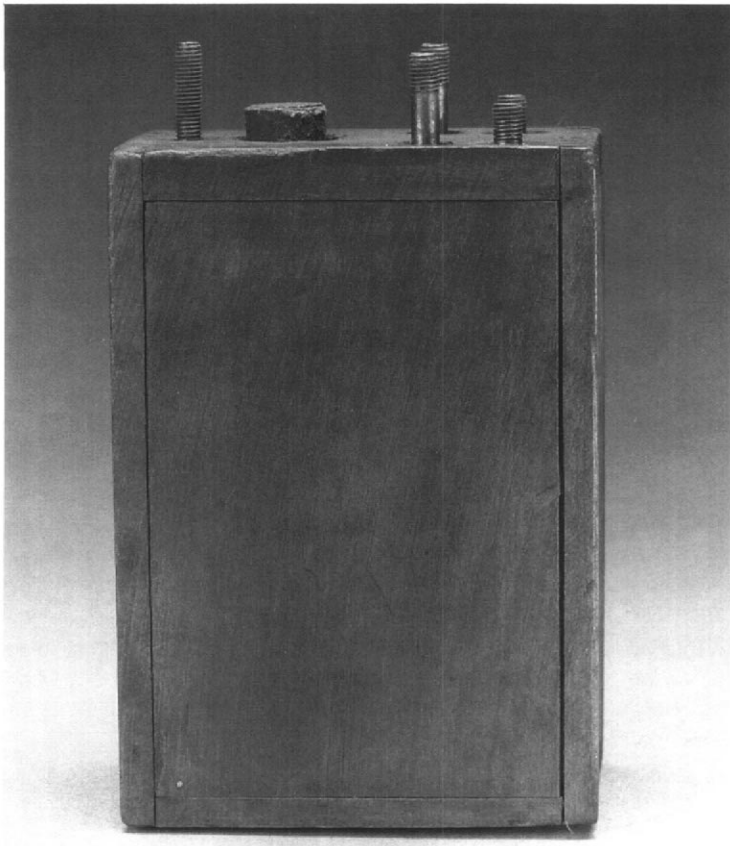

Photo 14: *The wood top coil used from mid-1917 until the spring of 1919. There is no Ford script on this coil.*

to have been an attempt to reduce the cost of manufacturing the coil by making the coil unit box in one operation instead of an assembly. Note that the point bridge support collars are cast into the top of the box in order to simplify design and reduce costs. (See Photo 19.) Records indicate that only the Ford Motor Company made this style of coil. The door on the right-hand side of the box was a sepa-

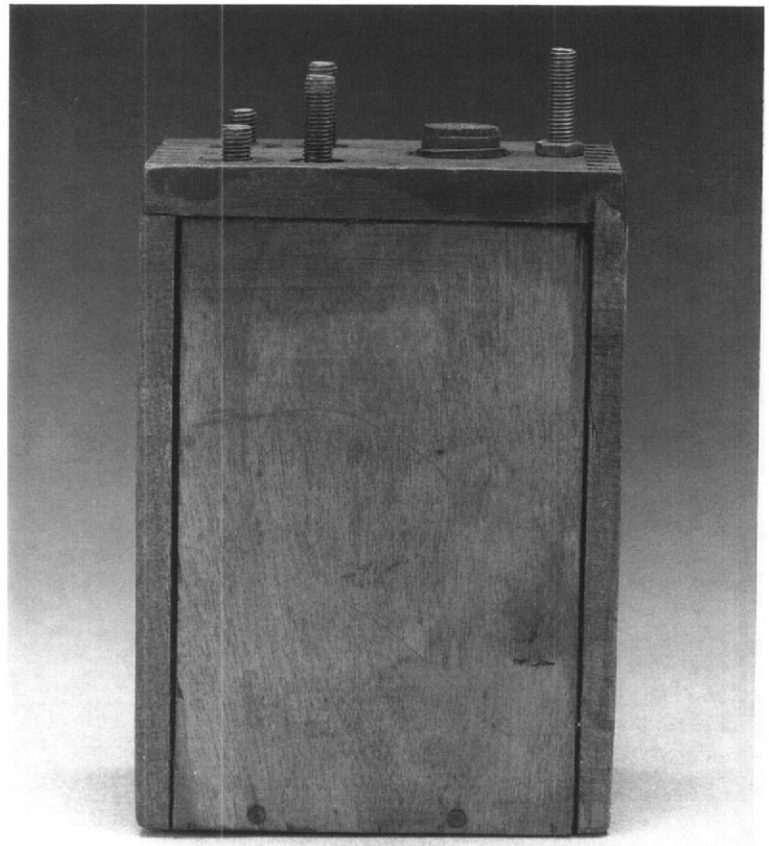

Photo 15: *Right-hand side of a 1917-19 wood top coil. The removable door is held in place with two brads at the bottom. The removable door on the 1916-17 brass top coils was attached in the same manner. The point mounting studs differ on this coil from the previous one, with the threads running the entire length of the studs. It appears that this was characteristic of K-W manufactured coils. Ford's mounting studs have threads that extend only about half the length of the stud. This is because Ford made its mounting studs using the "Cold Heading" process, while K-W used automatic screw machines to make the studs.*

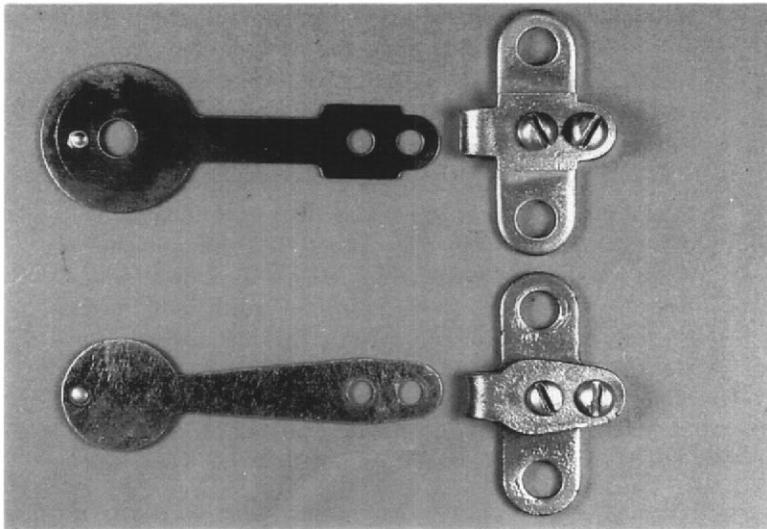

Photo 16: *View of the two vibrator spring mounting bases. The upper one was used prior to June 6, 1917, and the lower one with the arrowhead-shaped base was used after that date.*

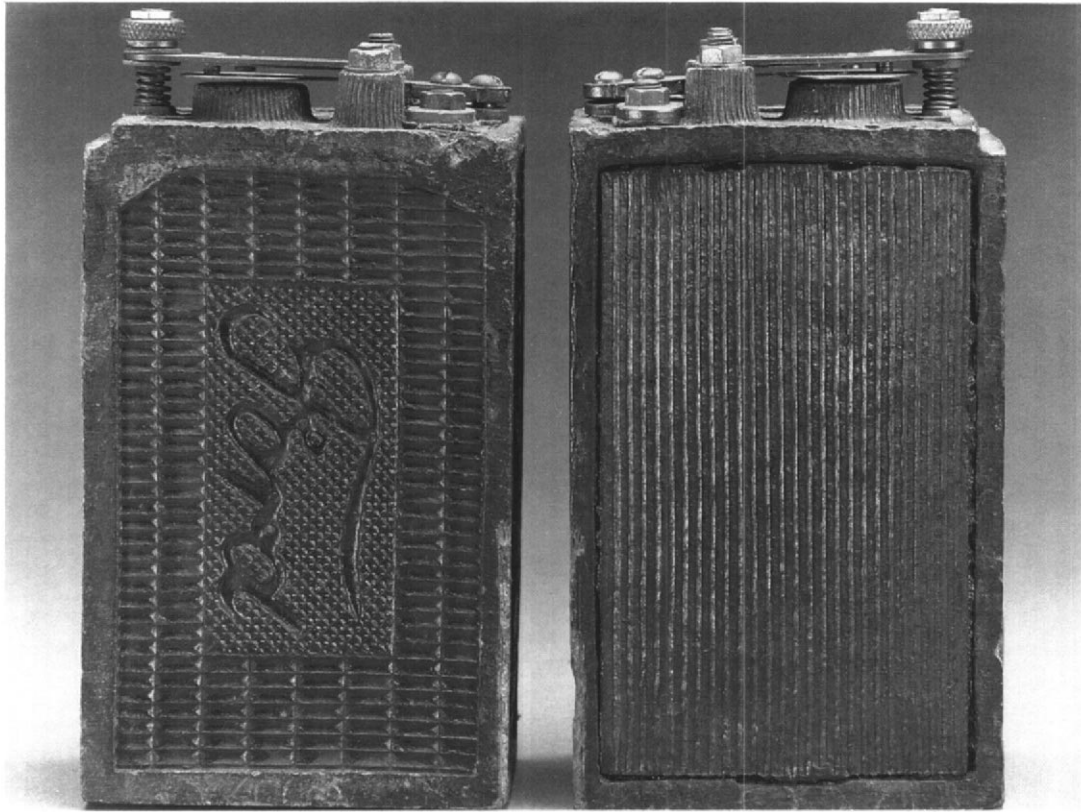

Photo 17 (top): Left-and right-hand views of the 1916-18 fiber case coils produced by the Ford Motor Company. The grooved surface in the right hand side is the "removable" door. The door is made of a plastic-like black material and is held in place by the Ford Hydrolene or insulating compound used inside the coil.

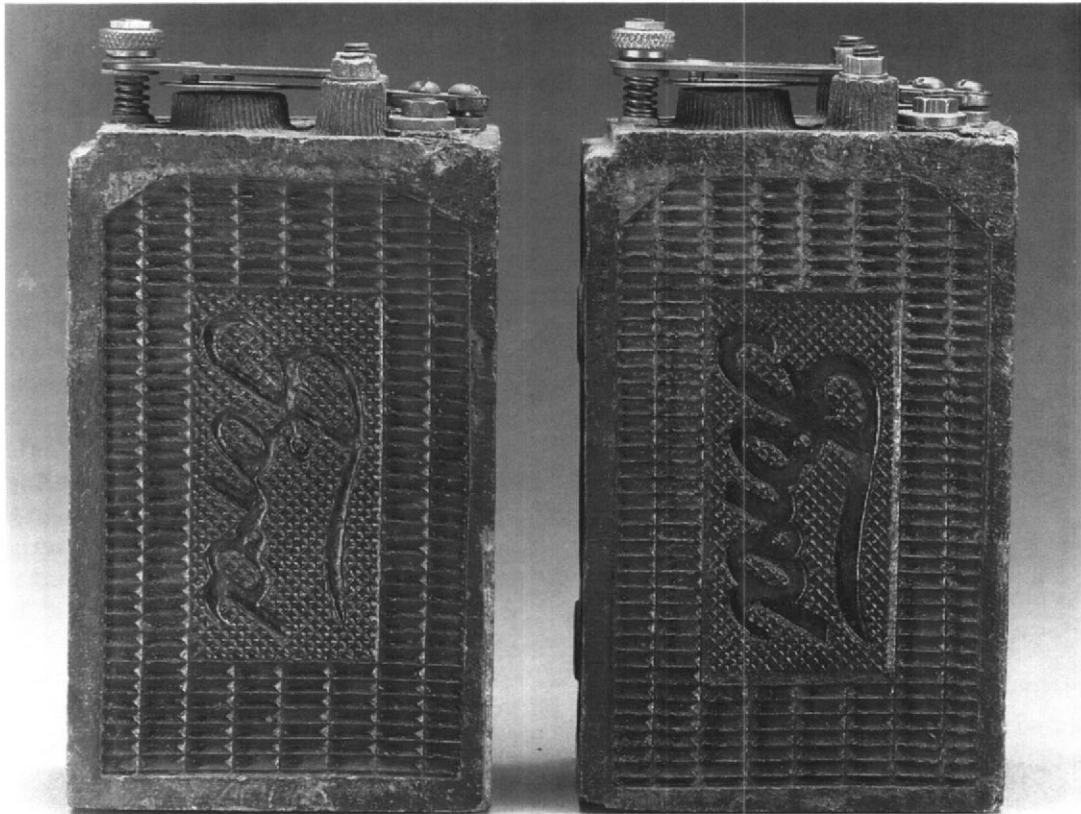

Photo 18 (bottom): Two fiber case coils that differ slightly in outside appearance around the Ford script

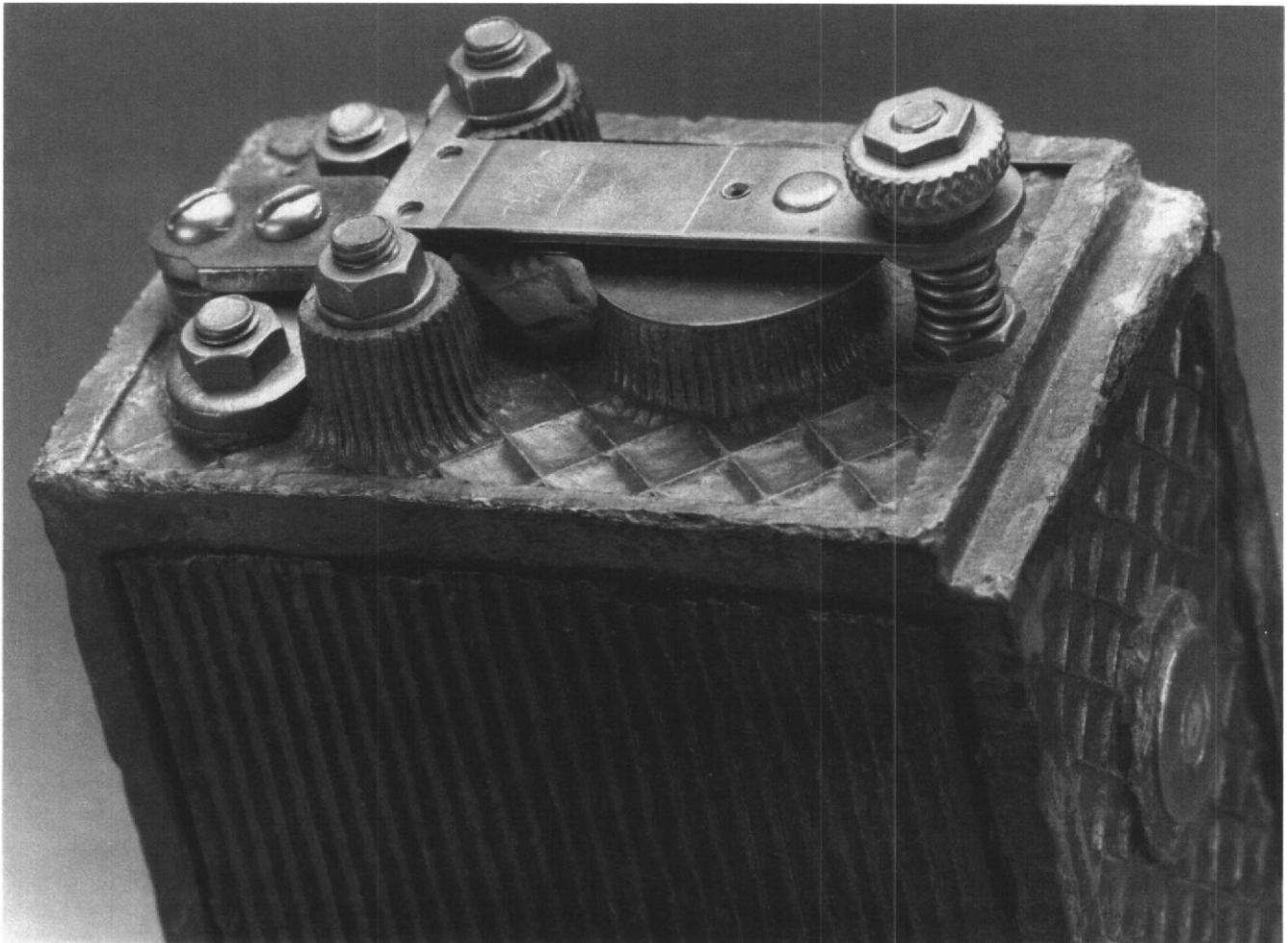

Photo 19: Top view of a 1916-18 fiber case coil showing how the contact bridge support collars were cast into the top of the box. Note the brass thumbnut that adjusts the point gap. This same thumbnut was used on the coil box terminals that extended through the dash of a Model T.

rate casting made from a black plastic-like material. When the internal parts of the coil were assembled and the interior filled with hot, molten Ford Hydrolene, the door was pressed into place and held by the Hydrolene after it had cooled.

The die cast design coils appear to suffer from dimensional stability problems. Either because of heat or because of moisture, the dimensions of these boxes appear to change over time. While this was also a problem with the wood-boxed coils, it appears to be a much greater problem with the fiber case coils.

For whatever reason, the fiber case coils were not considered to be a success by Ford. On March 2, 1918 the engineering records indicate that the use of the die cast design of the box was discontinued. Thereafter Ford, like K-W, made only wood-boxed coils.⁵

1919-1923 Ford Script Coils

During 1919 two changes occurred in the design of the coil unit that distinguish these coils from those produced before. First, on March 19, 1919 the

Ford engineers specified that the name "Ford" in script was to be branded into the left-hand side of the coil unit box.' (See Photo 20). A number of coil units have also been observed with the Ford script stamped into the removable door on the right-hand side of the box; however, the engineering records are silent on this practice. It is possible that coils with the stamped script on the door were supplied to Ford by Kokomo Electric (Kingston). It is also possible that these coils are simply a manufacturing aberration. (See Photo 21.)

The second change was to the base to which the vibrator armature spring was attached. In November 1919 the base was completely redesigned. The "grub screw" that Williams had hidden in his original design was eliminated and the new base was a simple steel stamping to which the spring was still attached with two small screws. Henceforth the tension on the vibrator armature spring would be adjusted by either tapping on the rear edge of the base with a small hammer, or by prying up against the rear edge with a screwdriver. (See Photo 22.)

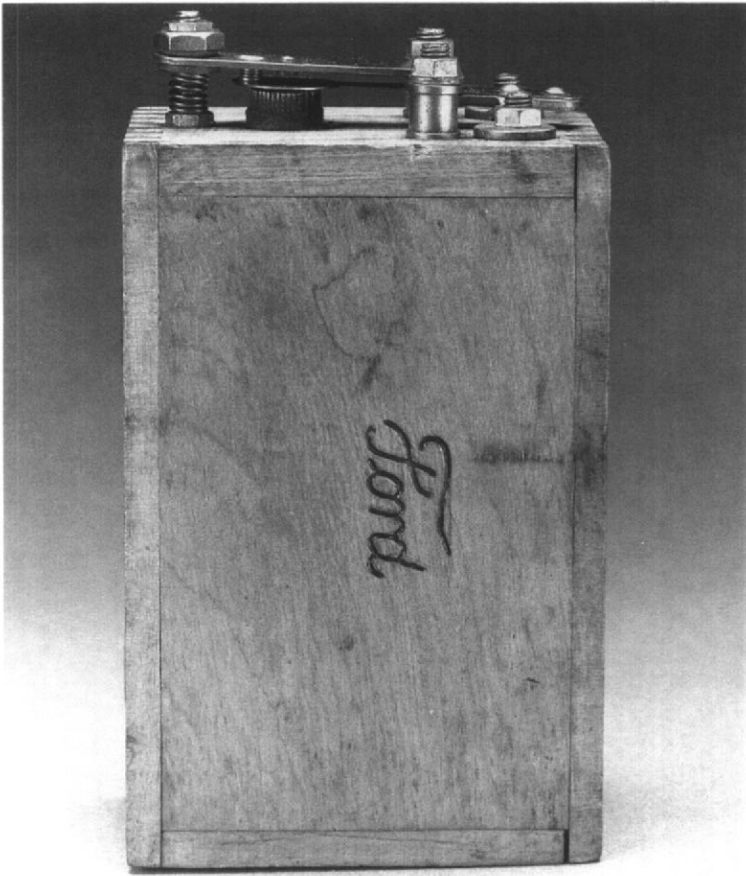

Photo 20: A typical 1919-23 wood box coil with Ford script burned into the left-hand side. The contact bridge support collars are probably not correct for a coil of this era.

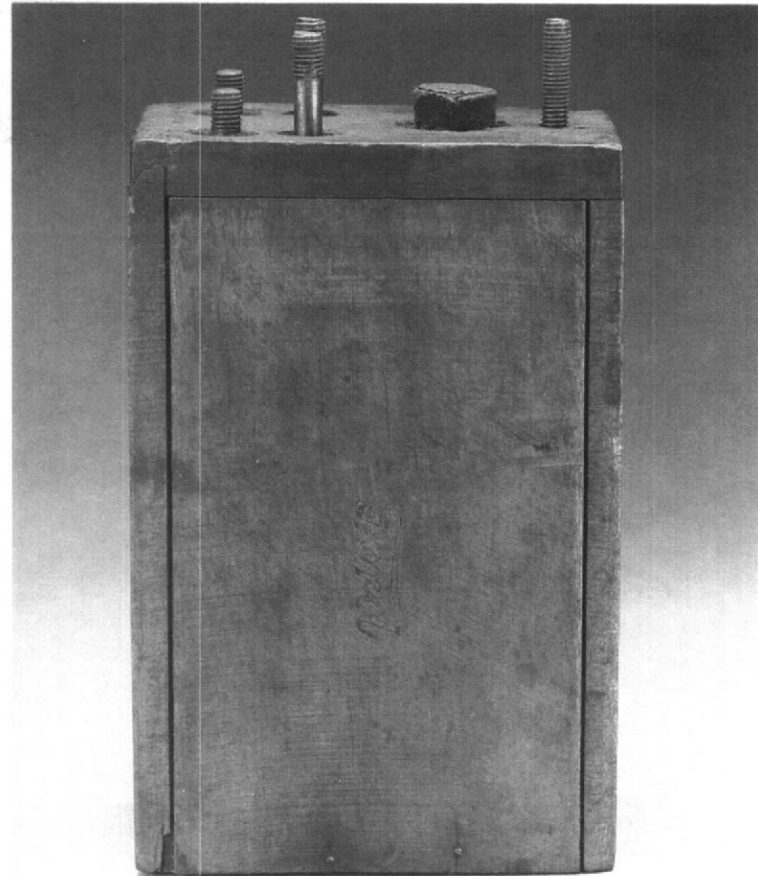

Photo 21: A coil with Ford script engraved into the removable door on the right-hand side. No mention of this practice has been found so far in the engineering records at the Research Center.

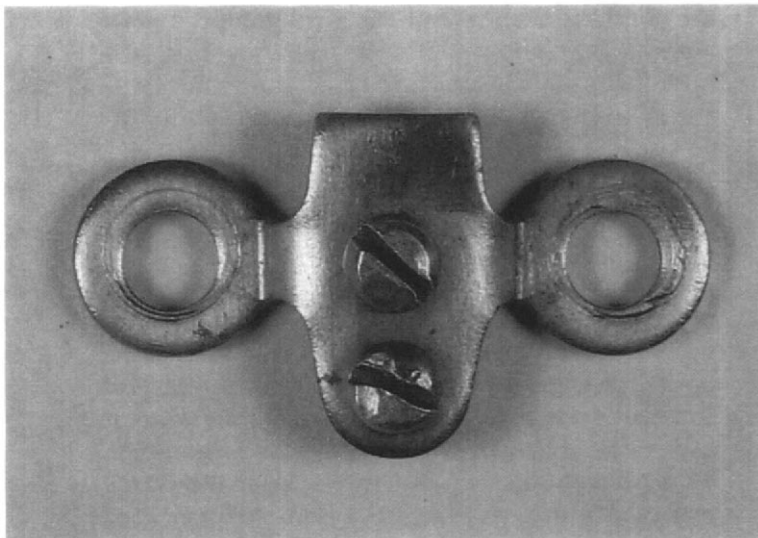

Photo 22: Beginning in 1919 the vibrator contact spring (also known as the vibrator armature) base was changed. Williams' grub screw design was replaced with a simple steel stamping. Hereafter, vibrator spring tension on Model T coils would be adjusted with a small hammer instead of a small screwdriver.

The Tractor Units

The Fordson tractor introduced during 1917 used the same basic ignition system, including a magneto, as the Model T. However, the operating conditions of the tractor were much harsher than those of a typical Model T car or truck. The engine

of the Fordson was expected to operate at high speed for long time periods. Since the coil box was attached to the left-hand side of Fordson's cylinder head, it and the four coil units were subjected to the high temperatures at which the tractor usually operated.

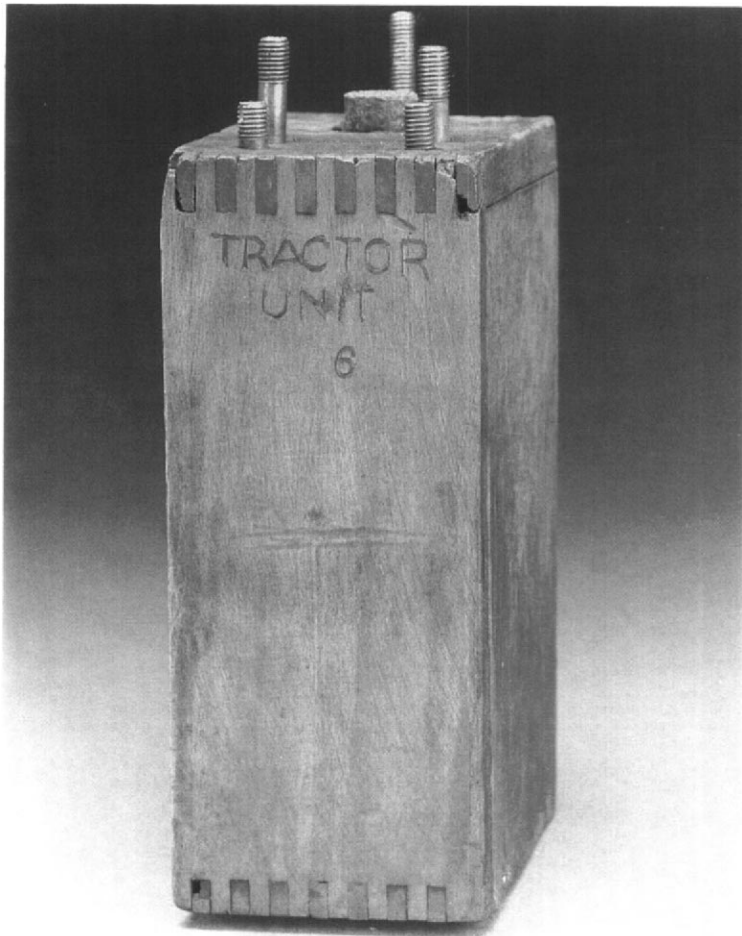

Photo 23: *Special coil units for the Fordson tractor were marked "Tractor units" from 1920 to 1922. These coils differed from regular Model T production in that they used a larger condenser and the melting point of the insulating compound (Ford Hydrolene) was higher than the standard material used in Ford cars and trucks.*

To compensate for these conditions, Ford introduced a special coil unit for the tractor in late 1919 or early 1920. This coil used a special condenser inside the coil and a set of heavy-duty points fitted with larger contacts than those used as standard equipment on the Model T. In addition, the specifications for the insulating compound inside the coil were changed to a much higher melting point in order to withstand the higher operating temperatures in the tractor environment. To distinguish this coil from its regular Model T counterpart, these coils were labeled with the words "Tractor Unit" stamped into the wood on the backside of the coil. (See Photo 23.)

Producing two different coil units, one for Model T cars and trucks and one for the Fordson tractor, was against Ford's practice of simplicity and standardization. During September of 1922 the regular Model T coil was upgraded to the same standards as the Fordson tractor coil. The words "Tractor Unit" were removed from the coils used on

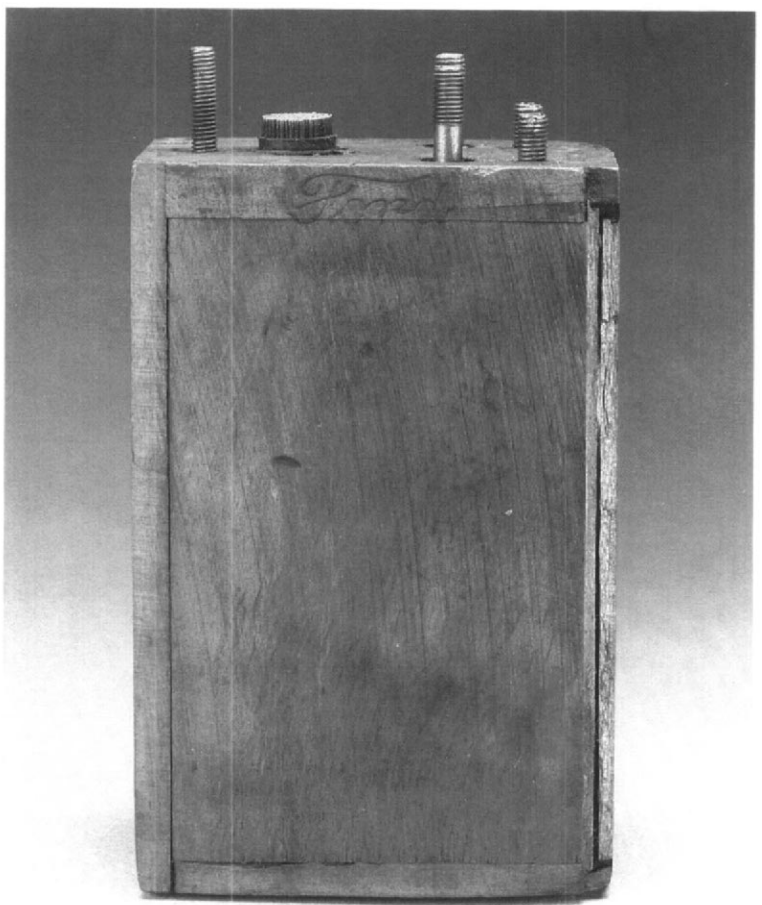

Photo 24: *Standard Ford/K-W coil used from 1923 on had the Ford script rolled into the top of the wood box on the left-hand side*

the Fordson tractor and all Ford-produced coils manufactured after September 1922 could be used interchangeably between the tractor and the car.⁶

1923-1927 Coils

During the last four years of Model T production, several additional changes in the coil units were made that distinguish them from their earlier counterparts. On February 28, 1923 the Ford engineers specified that the name and location of the name "Ford" in script be changed. It was moved from the middle of the left, or stationary side, of the box to the edge of the top stationary side of the box. Instead of the name being burned into the wood, it was to be rolled in with a die.' (See Photo 24.) Transitional coils from this time period have been observed which still have the Ford script burned into the left side of the box and that also have the Ford script rolled into the top of the box. (See Photo 25.)

In early April of 1923 Ford introduced an alternative design for the wood coil unit box. Ford engineering records refer to this as T-6793-A2 and indicate that the parts of this box were to be pro-



Photo 25: A few coils have been observed with both the Ford script burned into the side and rolled into the top of the left-hand side of the box. Evidently these were transition units built during the changeover from the earlier to the later style.

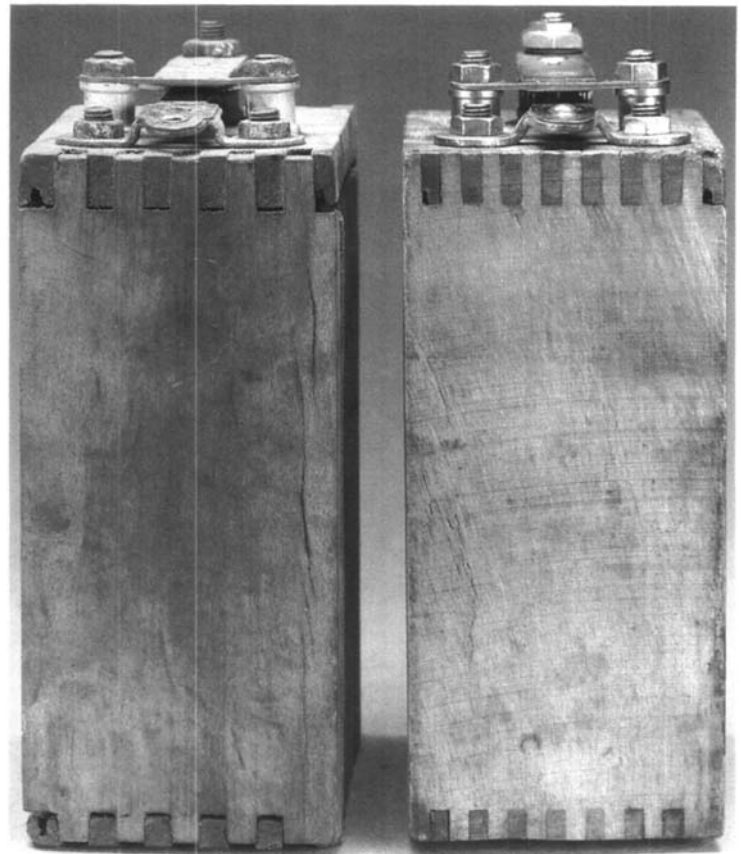

Photo 26: Comparison of the two designs of wood boxes used from April 1923 and later. The T-6393-A2 design (left) has fewer and wider fingers in the joints than the T-6393-A1 design (right). The A2 design was made only at Ford.

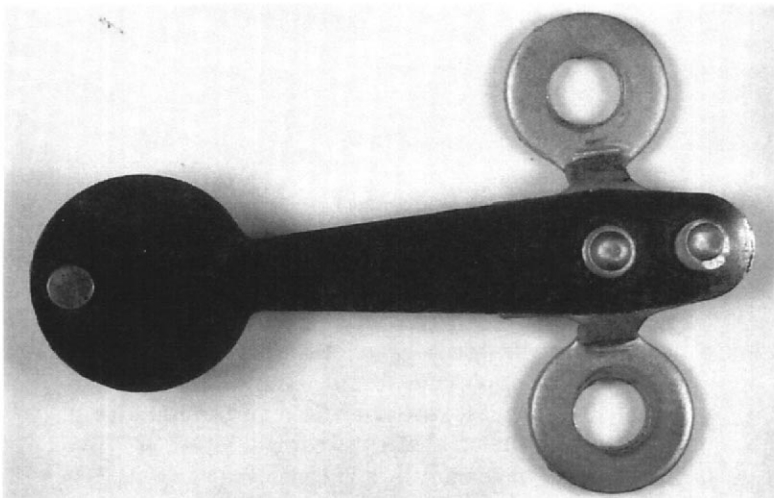

Photo 27: Beginning in mid-April 1924 the vibrator contact spring base was redesigned. The two mounting screws were replaced by riveting the vibrator spring directly to the base. Thereafter, both the base and the spring would have to be replaced as a unit.

duced in-house at Ford. It is distinguishable from the T-6793-A1 design wood coil unit box by the width and number of fingers in the joints between the top, bottom, front and rear sides. These wooden fingers are substantially wider in the A2 design and consequently there are only 11 fingers in the joints

as opposed to 16 fingers in the joints of the A1 design. (See Photo 26.)

Early in 1924 the vibrator spring base was redesigned a final time. The two small screws that attached the vibrator spring to its base were finally eliminated and the spring was permanently riveted

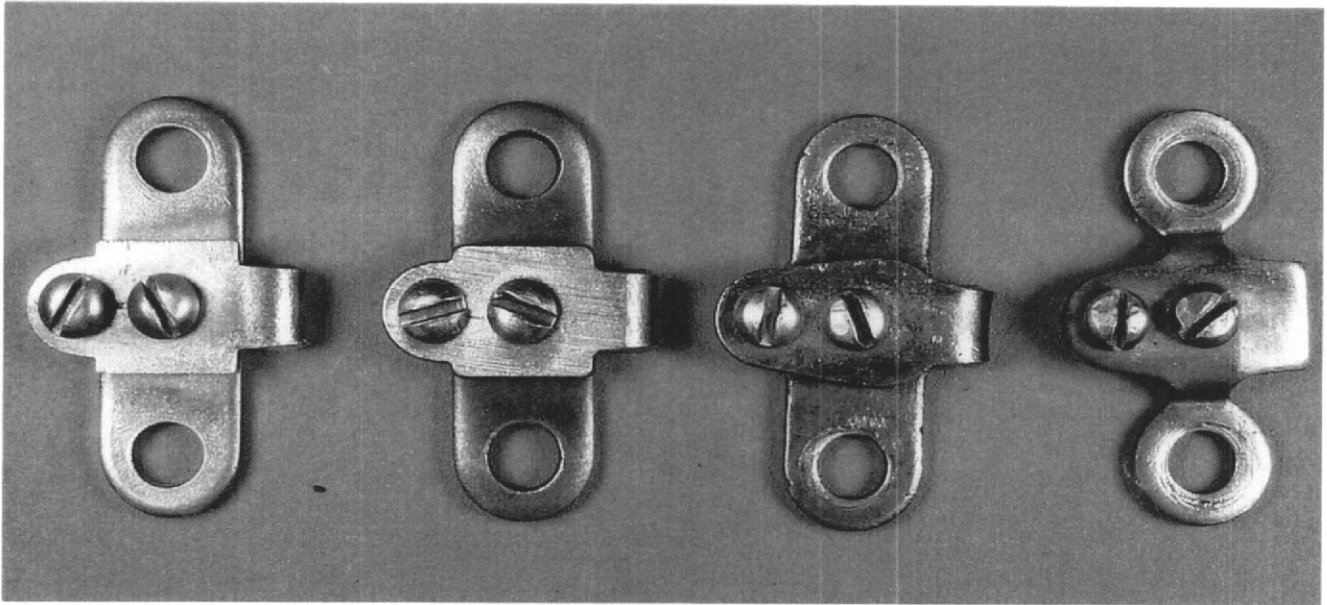
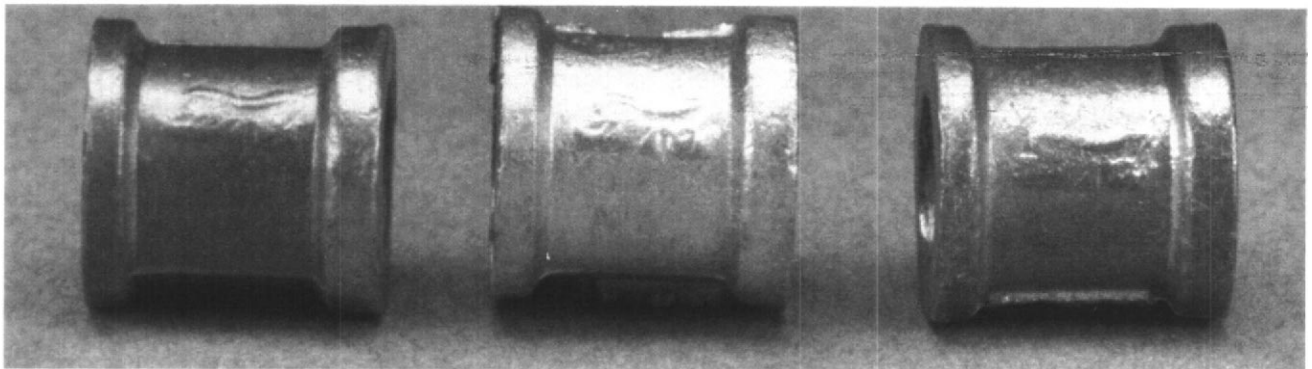

Photo 28: A comparison of the different vibrator contact spring bases used from 1913 to 1924. From left to right: All brass grub screw base used 1973-1917. Steel grub screw base with rectangular pad for contact spring used May-June 1917. Steel grub screw base with arrowhead-shaped pad for contact spring used June 1917 to November 1919. Stamped steel base without grub screw used November 1919 to August 1924.

Photo 29: Close-up view of the die cast aluminum upper bridge support collar or spool used from April 1926 forward.



to the spring. Beginning in mid-April the new combination vibrator spring and base assembly was put into “experimental manufacture,” a term Ford used to describe preliminary or pilot production of a part based on a new or different design. Four months later the old style was completely eliminated from production.⁹(See Photos 27 and 28.)

A notable change in the coil point mounting hardware took place on April 23, 1926. During the early 1920s Ford had experimented with making a number of parts for the Model T out of die cast aluminum. The Ford engineers concluded that the upper point bridge support collars could be produced using this process. Consequently, they were changed from copper-plated steel cylinders to aluminum spools. Several minor variations in these spools have been observed. This may be due to

either variations in the die casting moulds, or to different sources of supply. (See Photo 29.)

Other Model T Coils

A number of variations of regular production Model T coils have been observed for which no explanation has been found. One of these is the Ford “C” coil. This coil is marked on the removable door side of the coil with the capital letter “C.” The name Ford in script stamped into the same door is sometimes observed on these coils as well. The exact meaning of the letter “C” marking is unknown. We have speculated that it may refer to coils made in Canada. (See Photos 30 and 31.)

By the mid-teens a tremendous demand for replacement Model T coils had arisen. Replacement, or after market coils were supplied to auto-

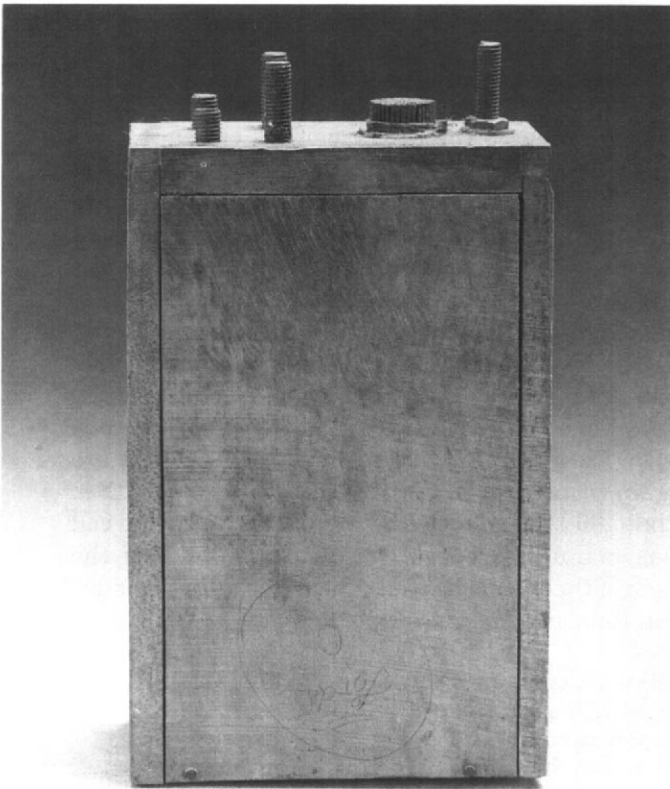

Photo 30: A Model T coil marked with Ford script and the letter "C"

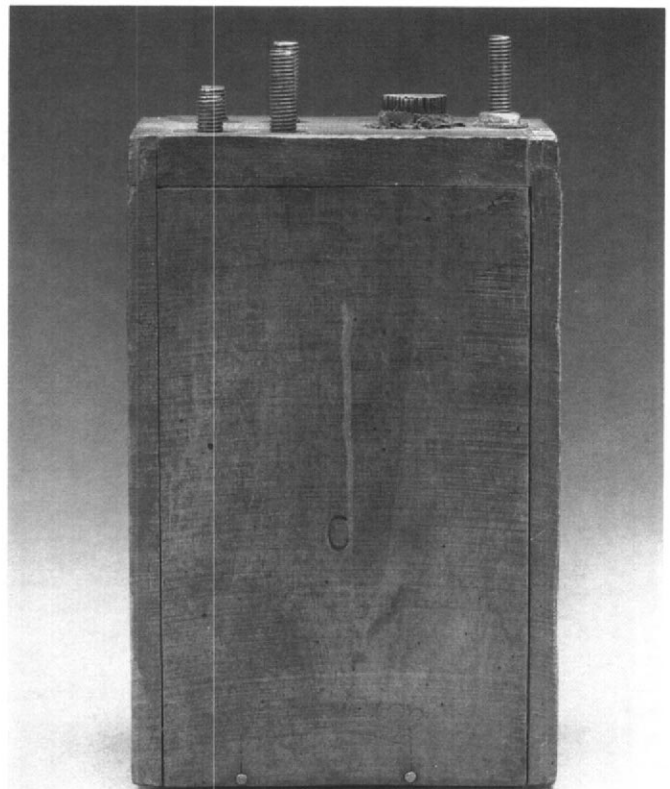

Photo 31: Another Model T coil simply marked with the letter "C." The significance of the letter "C" is not certain, but we suspect it may designate coils made for Ford of Canada by K-W Ignition.

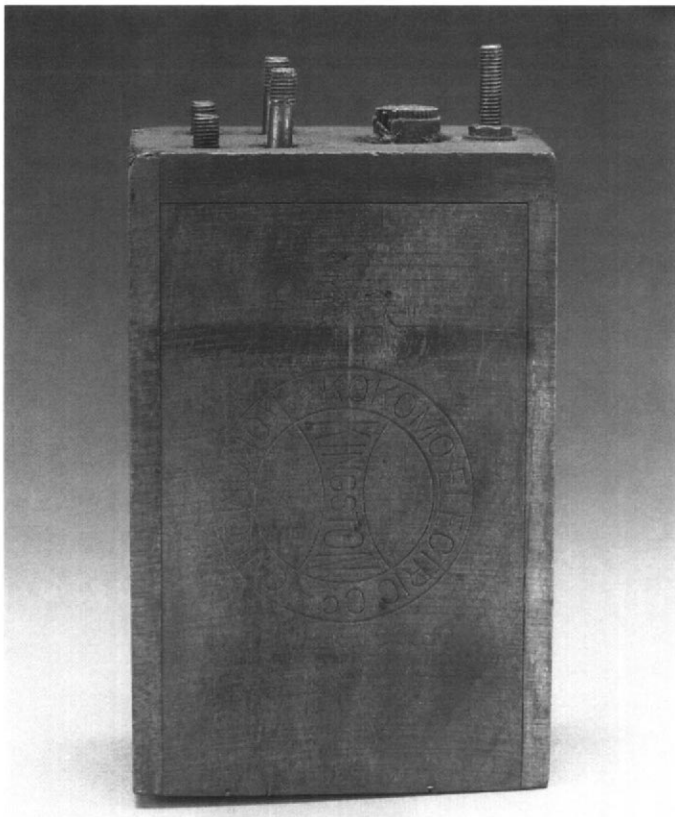

Photo 33: Another Kokomo Electric Company coil, this one also marked with the trademark "Kingston."
Kingston also supplied coils made under the Williams patent to Ford for use in new Model Ts.

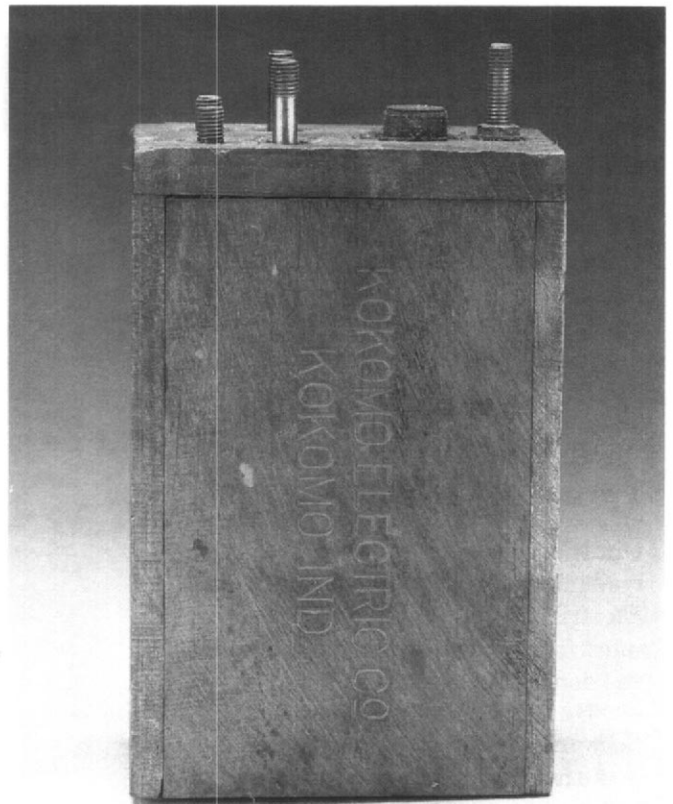

Photo 32: A Kokomo Electric Company coil marked in block letters

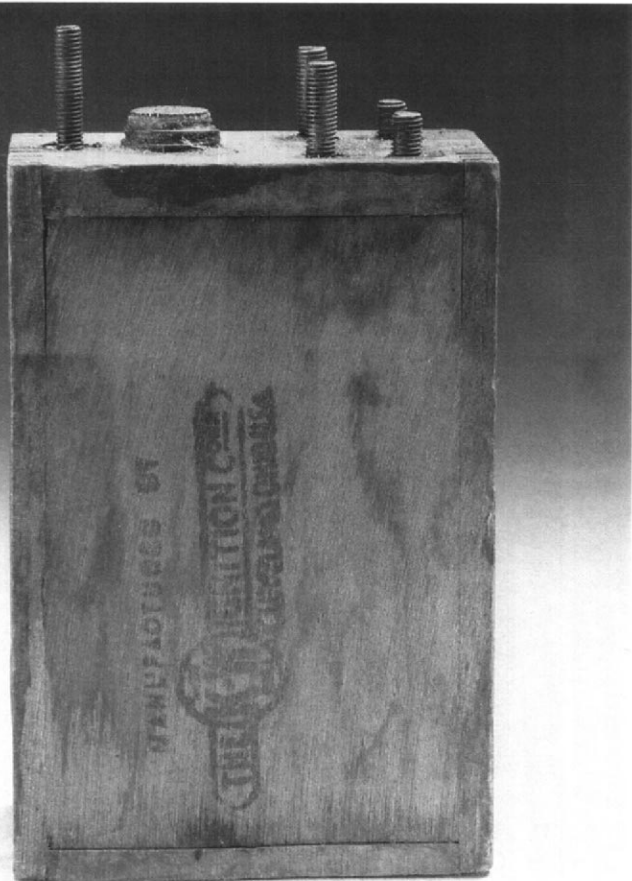

Photo 34: A K-W coil marked with the company's logo for supply to the aftermarket retail trade

motive jobbers and retailers by a number of different manufacturers. One of these suppliers to the retail trade was Kokomo Electric Company, makers of the Kingston coil. Kokomo Electric Company coils marked its coils by stamping its name into the removeable door of the coil. Two variations have so far been observed. On the first type, the name "Kokomo Electric Co Kokomo Ind" is stamped in block letter in two rows on the door of the coil. (See Photo 32.) On the second type the Kingston trademark with the legend "Kokomo Electric Co Kokomo Ind" surrounding it in a circle is found stamped into the door. (See Photo 33.)

By far the largest supplier of aftermarket coils to the retail trade was the K-W Ignition Company itself. Over the years K-W changed the way it marked its coils several times. The dating of these markings is only vaguely understood. Some early re-

placement K-W coils have the legend "Manufactured by The K-W Ignition Corp, Cleveland, Ohio, USA" printed on the left side of the coil unit. (See Photo 34.1) Other early K-W units have a simpler trademark burned into the back of the coil. On these coils the legend reads "Genuine K-W Made in U.S.A" with the letters K-W enclosed in a circle. Which marking came first is unclear. Nevertheless, the circle K-W brand set the pattern for marking K-W coils for the balance of wood box coil production. After the end of World War II, the coils marked K-W have the same legend as the previous coils with the marks burned in, but the markings are again printed in ink on the back of the coil. (See Photo 36.) Frequently the month and year the coil was manufactured will be found printed on the back of these coils as well. The dates observed have run from 1946 to a few dated as late as 1973. □

The authors may be contacted by writing:
 Trent E. Boggess
 Department of Business
 Plymouth State College
 Plymouth, NH 03264
 e-mail: Trentb@oz.plymouth.edu

Ronald Patterson
 8 Olde Surrey Lane
 Medway, MA 02053
 e-mail: Modeltcoils@sprynet.com



Photo 35: Three differently marked K-W coils. These coils were supplied to the aftermarket retail trade for Model T parts in the millions. Note that the studs used to attach the points to the top of the coil are threaded from top to bottom. This is characteristic of coils manufactured by K-W Ignition Co.

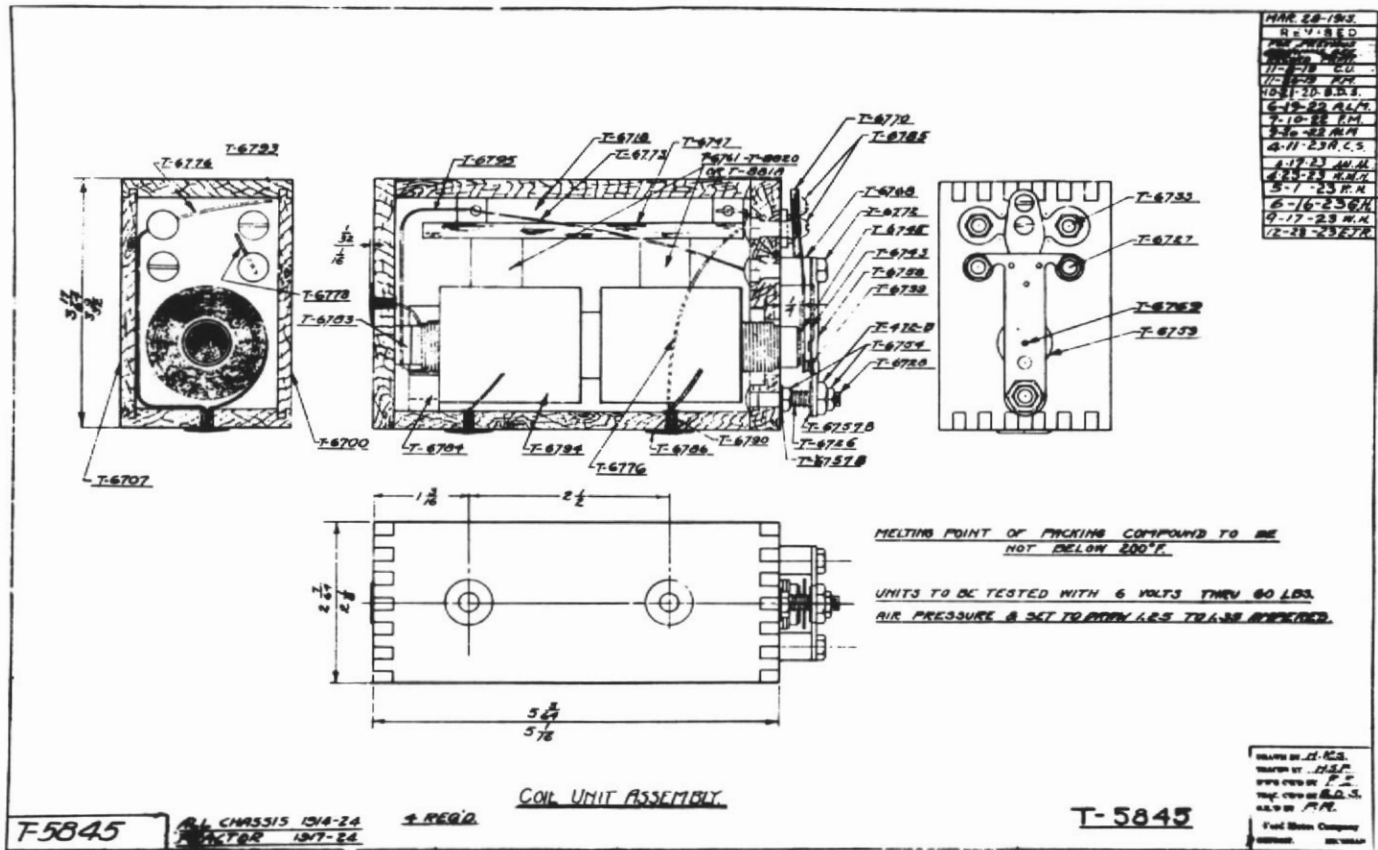

Photo 36: Engineering parts drawing for T-5845 - The Model T Coil Unit Assembly - dated December 28, 1923. From the collections of the Henry Ford Museum and Greenfield Village. Neg. No. T-5845.

Detailed Engineering Specifications for the Ford/K-W Vibrator Coil¹⁰

<u>Windings</u>	
Primary:	212 turns
Secondary:	16,600 turns
Ratio:	78 to 1
<u>Direct Current Resistance</u>	
Primary:	0.295 Ohms
Secondary:	3,300 Ohms
<u>Inductance in Henrys</u>	
Primary with secondary open:	0.0033 Henrys
Primary with secondary shorted:	0.0006 Henrys
Secondary with primary open:	22.0 Henrys
Secondary with primary shorted:	11.3 Henrys
<u>Impedance in Ohms at 133 cycles (25 M.P.H.)</u>	
Primary with secondary open:	2.77 Ohms
Primary with secondary shorted:	0.580 Ohms
Secondary with primary open:	18,700 Ohms
Secondary with primary shorted:	9,960 Ohms
<u>Capacity of Condensor</u>	0.40 - .45 MFD

- ### Footnotes
- ¹ Releases for T-6768 Vibrator Bolt Collar, Model T Releases, Accession 1701, Box 4, Research Center, Henry Ford Museum and Greenfield Village. Hereafter cited as Research Center.
 - ² Releases for T-6793 Coil Unit Box, Model T Releases, Accession 1701, Box 4, Research Center.
 - ³ Ibid.
 - ⁴ Releases for T-6711-A Coil Unit Box, T-6768: Bridge Support, T-6772: Point Nuts, and T-472-B: Bridge Adjusting Nut, Model T Releases, Accession 1701, Boxes 2 and 4, Research Center.
 - ⁵ Releases for T-6793 Coil Unit Box, Model T Releases, Box 4, Accession 1701, Research Center.
 - ⁶ Releases for T-6793 Coil Unit Box, Model T Releases, Accession 1701, Box 4, Research Center.
 - ⁷ Ford Service Bulletins, Feb. 1, 1920 and October 1922, Ford Motor Company, Dearborn, Michigan.
 - ⁸ Releases for T-6793 Coil Unit Box, Model T Releases, Accession 1701, Box 4, Research Center.
 - ⁹ Releases for T-6770 Vibrator Bridge Lower, Model T Releases, Accession 1701, Box 4, Research Center.
 - ¹⁰ Accession 94, Box 171, Folder: Ignition 1916, Folder 1 of 2, Research Center.